

S-PLAY – User Manual



Record, Edit and Playback up to 32 Universes using Art-Net/sACN or 2 Universes using the two built in DMX ports with an all-in-one show recorder.



ENTTEC's S-PLAY is a highly accurate, 32 universes lighting record and playback controller.

Capture or create static scenes or record dynamic cues from up to 32 universes of Art-Net, sACN or 2 universes of DMX. The built-in pixel effects generator provides an intuitive tool to create the desired look to be output to your pixel controller.

Using either RS232, Art-Net, DMX, Digital Inputs, Relays, sACN, UDP or OSC; send commands to external devices or receive triggers the device allows external devices to fully integrate the S-PLAY into the installation.

Using the intuitive drag and drop timelines system, build playlists using cues, events and triggers as building blocks. Control the number of play counts, priority, fade times and master intensities to fine tune your playlists.

Build schedules of playlists to play at certain times of the day or utilize external triggers to allow multiple playlists to run over the top of each other at the same time with different groups and priorities.

Features

- **In-built controls to record and play cues**
- **Internal memory supporting over 10 hours of 32 universe recording at 44FPS (plug in an external SD card to increase this recording size).**
- **Variable Art-Net/sACN refresh rate (60FPS max.).**
- **The ability to increase storage using an SD card.**
- **Four digital inputs to trigger device from external sources.**
- **Two relay outputs to control devices.**
- **Monitor the DMX values for recording cues.**
- **Create playlists from dynamic, static and internal effect cues.**
- **Add events and triggers to playlists.**
- **Two universe Physical DMX input or output.**
- **Up to 32 Universes of Art-Net and sACN recording & playback.**
- **Schedule playlists.**
- **Remote trigger options: RS232, Art-Net, DMX, Digital Inputs, sACN, UDP, OSC.**

Content

Safety.....	5
Electrical safety.....	5
System Planning and Specification	5
Protection from Injury During Installation	6
Installation Safety Guidelines.....	6
Physical Dimensions.....	7
Mounting Options.....	7
Wiring Diagrams.....	8
S-PLAY to distributed DMX Output	8
S-PLAY to Playback to Pixel Systems	9
S-PLAY Application Diagram.....	10
Connection to Relays.....	10
Connection to Digital Inputs.....	11
Using Motion Sensors with the S-PLAY	11
Functional features	13
Overview.....	13
Hardware features.....	14
Overview.....	14
S-PLAY Connectivity.....	15
LCD Menu Screen.....	15
Controls.....	15
Home Screen.....	15
Playlist Menu.....	16
Network Menu	16
Utilities Menu	16
Information Menu	17
Out of the Box.....	17
Network Discovery	17
View the S-PLAYs LCD.....	17
Finding an S-PLAY's IP Address from NMU.....	18
Changing the Network Settings.....	18
Changing the Network Settings Using LCD Interface.....	18
Change IP Using the Web Interface.....	18
Web interface	20
Home.....	20
Cue Library	20
Static Scenes.....	21
DMX Snapshot.....	22
Cue Creation.....	22
Dynamic Recordings.....	23
To create a new Dynamic Cue	23

Dynamic Recording Control.....	23
Effects	24
Preview Cue.....	24
Editing a Cue, Effect or Dynamic Recording.....	24
Events.....	25
RS232	25
UDP.....	25
OSC.....	26
Relay.....	26
Art-Net.....	26
sACN.....	27
DMX.....	27
Triggers.....	28
RS232	28
UDP.....	29
OSC.....	29
Digital Input.....	29
Art-Net.....	30
sACN.....	30
DMX.....	30
Playlists.....	31
Playlists Page Layout.....	32
Created Playlists.....	32
Global Playlist Control.....	33
Search and Filter Bar	33
Available Cues and Controls.....	33
Playlist Attributes	33
Playlist Settings	35
Playlist Timeline and Media Tracks.....	35
Event and Trigger Tracks	36
Scheduler.....	37
Created Schedules.....	38
List of Schedules.....	38
Schedule Name.....	39
Selected Playlist.....	39
Start Condition.....	39
End Condition	39
Frequency Type	40
Settings.....	42
S-PLAY Output	44
Art-Net Output Configuration.....	44
sACN output configuration.....	45
Change Date/Time and Location.....	45

Configure Remote Access Using SSH Tunnelling - (Advanced Feature)	45
Select Storage	46
Factory Reset	46
Factory Reset Via LCD	47
Factory Reset Via Web Interface	47
Status	47
Network Information	48
Output Information	48
System Information	49
Software Information	49
Backup	49
Backup	50
Restore	50
Export Playback Data	51
Storage	51
Show Storage	51
Static Cue	51
Dynamic Cue	51
Triggers & Events	51
Locking the S-PLAY and User Management	52
Lock Feature	52
Default Login and Passwords	53
Ports	54
XLR5 Female (DMX-512)	54
DB9 Male (RS232)	54
GPIO	55
Relay	55
Servicing, Inspection & Maintenance	56
Cleaning	56
Package Contents	57
Ordering Information	57

Safety

 **Ensure you are familiarized with all key information within this guide and other relevant ENTTEC documentation before specifying, installing, or operating an ENTTEC device. If you are in any doubt about system safety, or you plan to install ENTTEC device in a configuration that is not covered within this guide, contact ENTTEC or your ENTTEC supplier for assistance.**

ENTTEC's return to base warranty for this product does not cover damage caused by inappropriate use, application, or modification to the product.

Electrical safety

- 
- This product must be installed in accordance with applicable national and local electrical and construction codes by a person familiar with the construction and operation of the product and the hazards involved. Failure to comply with the following installation instructions may result in death or serious injury.
 - Do not exceed the ratings and limitations defined in the product datasheet or this document. Exceeding can cause damage to the device, risk of fire and electrical faults.
 - Ensure that no part of the installation is or can be connected to power until all connections and work is complete.
 - Before applying power to your installation, ensure your installation follows the guidance within this document. Including checking that all power distribution equipment and cables are in perfect condition and rated for the current requirements of all connected devices and factor in overhead and verify that it is appropriately fused and voltage is compatible.
 - Remove power from your installation immediately if accessories power cables or connectors is in any way damaged, defective, shows signs of overheating or are wet.
 - Provide a means of locking out power to your installation for system servicing, cleaning and maintenance. Remove power from this product when it is not in use.
 - Ensure your installation is protected from short circuits and overcurrent. Loose wires around this device whilst in operation, this could result in short circuiting.
 - Do not over stretch cabling to the device's connectors and ensure that cabling does not exert force on the PCB.
 - Do not 'hot swap' or 'hot plug' power to the device or its accessories.
 - Do not connect any of this devices V- (GND) connectors to earth.
 - Do not connect this device to a dimmer pack or mains electricity.

System Planning and Specification

- 
- To contribute to an optimal operating temperature, where possible keep this device out of direct sunlight.
 - Any twisted pair, 120ohm, shielded EIA-485 cable is suitable to transmit DMX512 data to or from the DIN ETHERGATE. The DMX cable should be suitable for EIA-485 (RS-485) with one or more low capacitance twisted pairs, with overall braid and foil shielding. Conductors should be 24 AWG (7/0.2) or larger for mechanical strength and to minimize volt drop on long lines.
 - A maximum of 32 devices should be used on a DMX line before re-generating the signal using a DMX buffer/ repeater / splitter.
 - Always terminate DMX chains using a 120Ohm resistor to stop signal degradation or data bounce-back.
 - The maximum recommended DMX cable run is 300m (984ft). ENTTEC advises against running data cabling close to sources of electromagnetic interference (EMF) i.e., mains power cabling / air conditioning units.

- This device has an IP20 rating and is not designed to be exposed to moisture or condensing humidity.
- Ensure this device is operated within the specified ranges within its product datasheet.

Protection from Injury During Installation



- Installation of this product must be performed by qualified personnel. If ever unsure always consult a professional.
- Always work with a plan of the installation that respects all system limitations as defined within this guide and product datasheet.
- Keep the S-PLAY and its accessories in its protective packaging until final installation.
- Note the serial number of each S-PLAY and add it to your layout plan for future reference when servicing.
- All network cabling should be terminated with an RJ45 connector in accordance with the T-568B standard.
- Always use suitable personal protective equipment when installing ENTTEC products.
- Once installation is completed, check that all hardware and components are securely in place and fastened to supporting structures if applicable.

Installation Safety Guidelines



- The device is convection cooled, ensure it receives sufficient airflow so heat can be dissipated.
- Do not cover the device with insulating material of any kind.
- Do not operate the device if the ambient temperature exceeds that stated in the device specifications.
- Do not cover or enclose the device without a suitable and proven method of dissipating heat.
- Do not install the device in damp or wet environments.
- Do not modify the device hardware in any way.
- Do not use the device if you see any signs of damage.
- Do not handle the device in an energized state.
- Do not crush or clamp the device during installation.
- Do not sign off a system without ensuring all cabling to the device and accessories has been appropriately restrained, secured and is not under tension.

Physical Dimensions

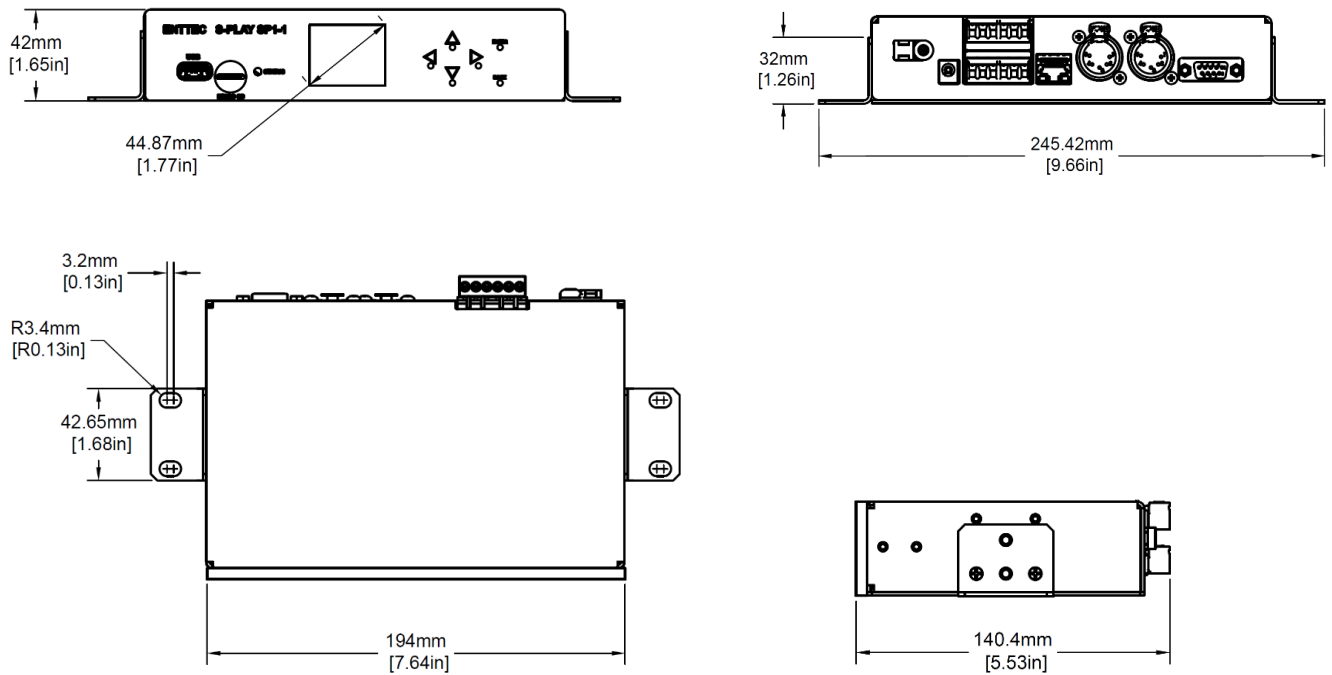

Note: All dimensions are in millimetres (mm).

Mounting Options

The S-PLAY is provided with ENTTEC's, 1RU mount kit (pn: 79105). To provide 9.5" rack and various surface/wall mounting solutions.



Note: The S-PLAY mounting solution is not intended to be suspended above head height or audiences. Ensure all relevant legal safety guidelines are followed when installing this device.

Wiring Diagrams

S-PLAY to distributed DMX Output

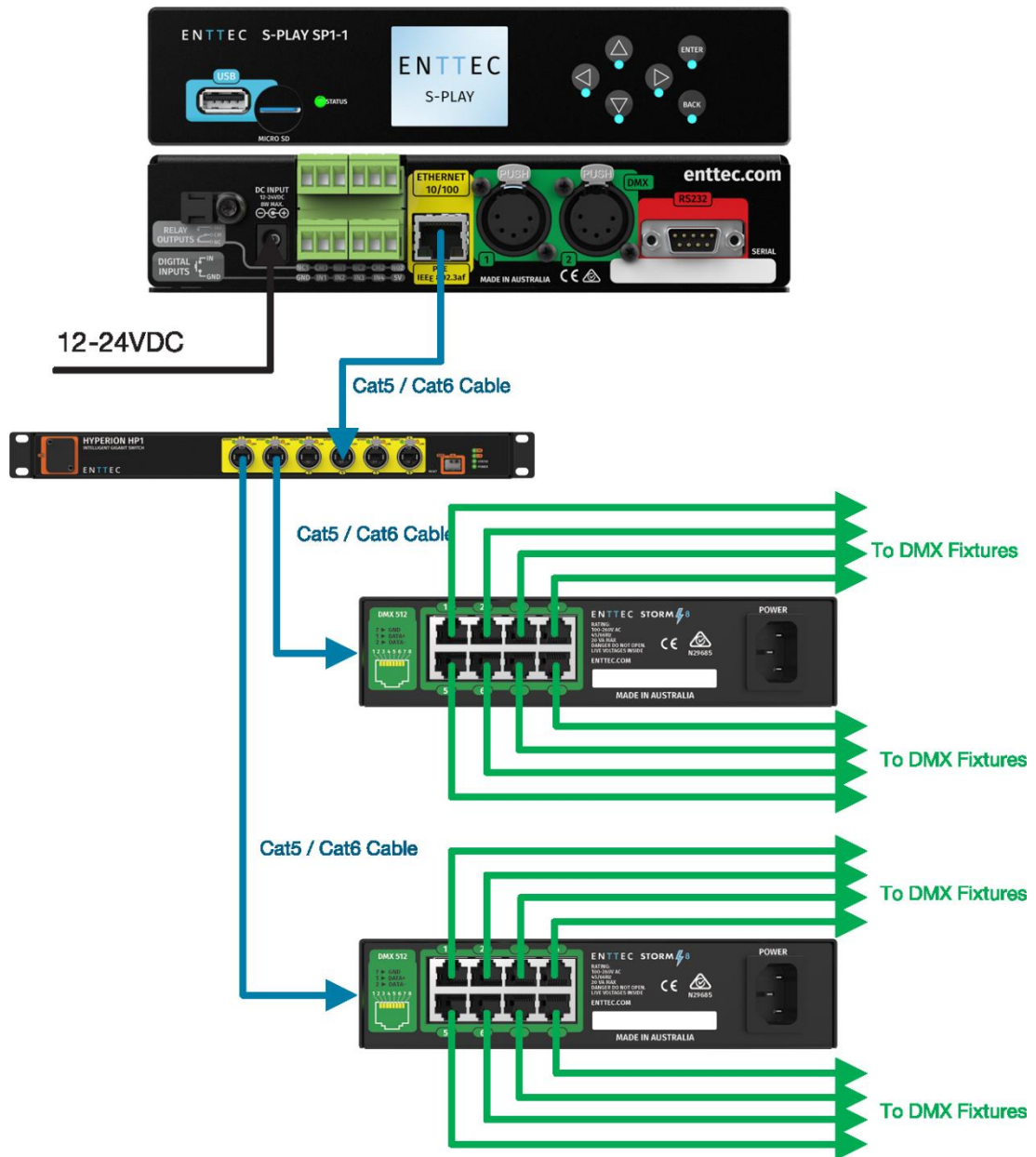

S-PLAY to Playback to Pixel Systems

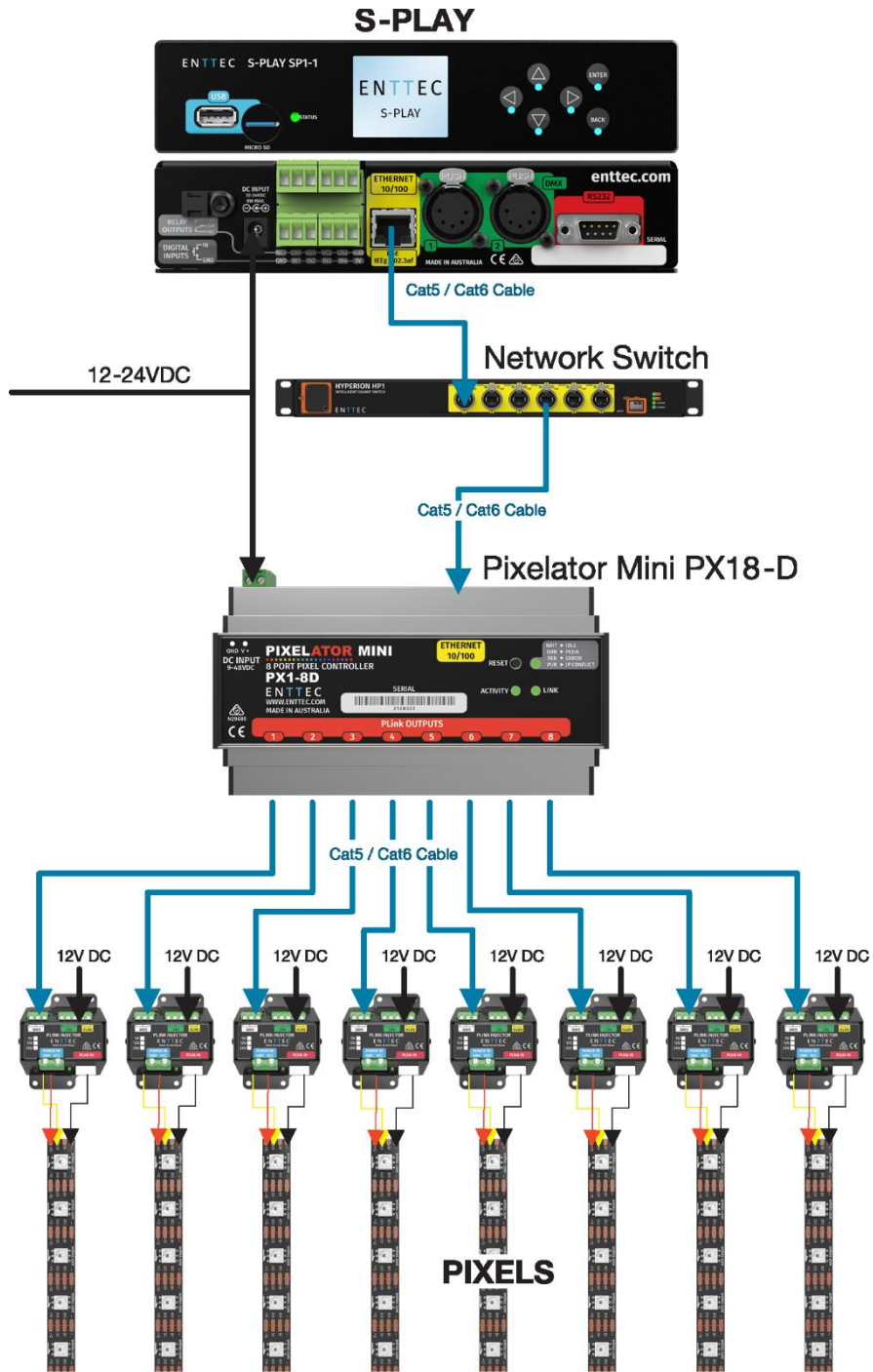

S-PLAY Application Diagram

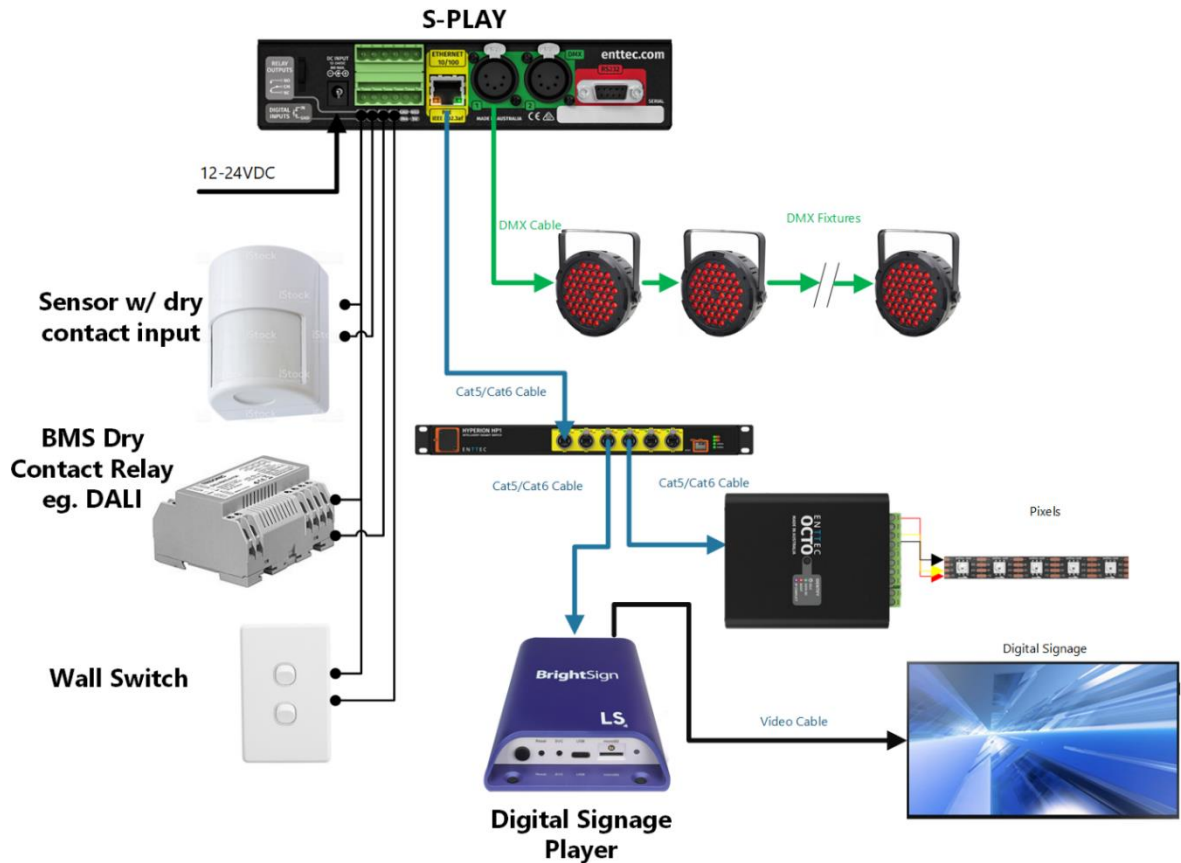

Connection to Relays

The S-PLAY features relays designed for use with low power devices and to provide switching logic for higher power contactors.

To ensure a safe installation it is imperative that the power connected to the S-PLAY relays is within their operating limits:

The S-PLAY's relay specifications are as follows:

Maximum Current Rating	2A
Maximum Voltage Rating	50V DC
Total switchable power of each S-PLAY relay	60W

To calculate the total power your circuit will pass through the relay, multiply the circuit voltage by the current you intend to pass through it. This value must be lower than 60w.

	Example 1	Example 2	Example 3
Current	1.2A	2A	2A
Voltage	50V	30V	50V
Maximum Power	60W	60W	100W

If your application requires mains power switching or high current applications, ENTTEC recommends the use of a DMX switch pack controlled by the S-PLAY's DMX output, or wire the S-PLAY's relay outputs to connect to the primary coil of a DIN mount high powered relay or contactor.

Connection to Digital Inputs

The S-PLAY's digital inputs detect circuit completion to the S-PLAYS 'GND' (V- terminal) to send triggers.

- The maximum resistance of a cable that can be used to connect to a Digital Input to the S-PLAYS GND is **20 Ohms**.
- ENTTEC recommends a total maximum wire length of 100m. (50m total distance from the S-PLAY in a loop).
- The longer the cable, the higher it's capacitance and likelihood of interference from EMF (Electro Magnetic Interference).
- To ensure a reliable trigger when creating a system, contact should be made for 3 seconds when triggering a digital input.

Note: Always run digital input cabling away from mains power or high sources of EMI (i.e. air conditioning units) to reduce interference.

i If you require a remote input trigger further away from the S-PLAY than 50m, ENTTEC recommend the use of a 3rd party GPIO interface that can communicate with the S-PLAYS other triggering methods over a network.

Using Motion Sensors with the S-PLAY

CONNECTION

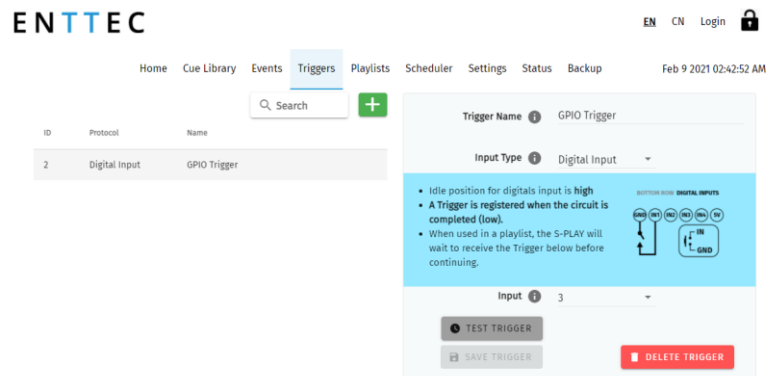
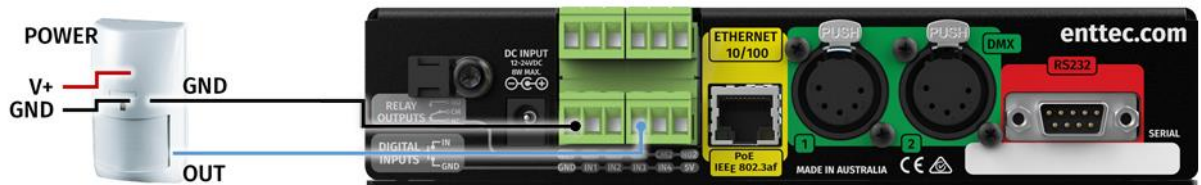

1. Connect a dry input from sensor to Port3 (or any other port), in the GPIO trigger connector in S-PLAY.
2. Connect 0V (GND) from the S-PLAY GPI through the connector in the S-PLAY.
3. Go to web interface:
 - Go to Triggers.
 - Create a new entry.
 - Select Digital Input from Type
 - Change to Port 3 in "Ports" (or to the corresponding port the OUT cable was connected to).
 - You can use the Test Trigger option to ensure functionality.
 - Click on Save Trigger for it to be saved ready for use on the Playlists page.

4. Navigate to the Playlists Page.

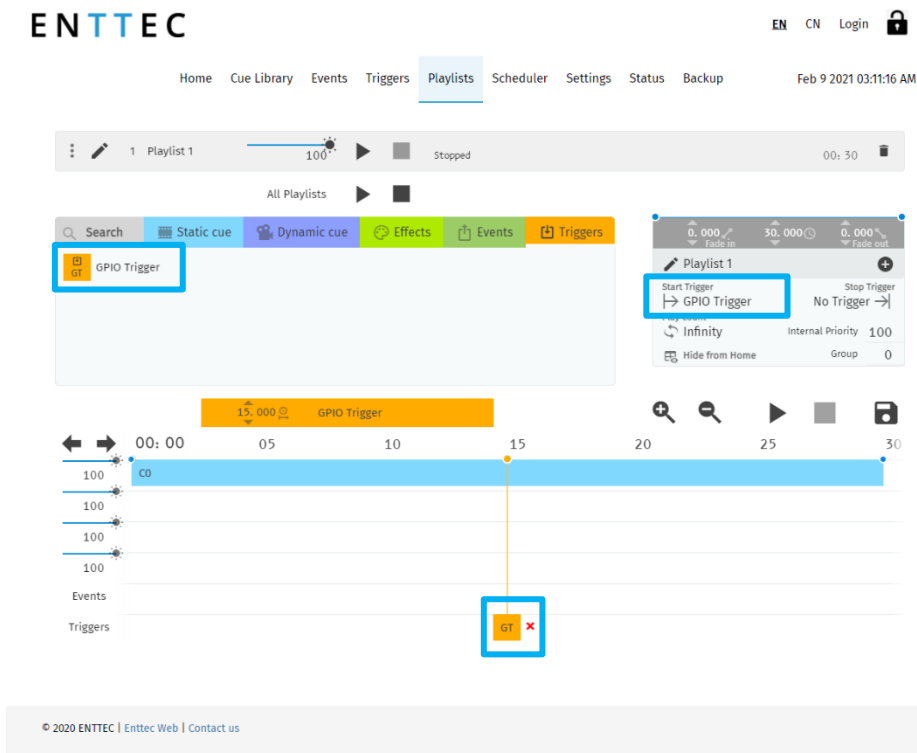

5. The Trigger can be selected as a 'Start Trigger' to commence playback of a certain playlist and/or dragged onto the timeline to act as a condition that must be met for playback to continue.

Functional features

Overview

- Supports Physical DMX and eDMX over Network:
 - Art-Net
 - sACN
 - DMX512-A
- 2 Universe DMX output or input.
- Up to 32 Universe Art-Net and sACN input or output.
- Create / edit DMX Scenes (static cue).
- Create / edit DMX Presets (dynamic cue).
- Preview cues being created.
- Monitor the DMX values of cues being made.
- Configurable output refresh rate. (Max 60FPS eDMX, 44Hz Physical).
- Make playlists from DMX Presets (dynamic cue).
- Make live recordings using DMX/Art-Net/sACN.
- Schedule playlists.
- Map different streams and protocols to different ports.
- HTP merge between cues and playlists.
- Fade out on Stop command.
- Hold last value on pause.
- Remote trigger options: RS232, UDP, OSC, Digital Input (GPI), Art-Net, sACN and DMX.
- HTTP and OSC Device API.
- Lock out edit functionality using a password.

Hardware features

Overview

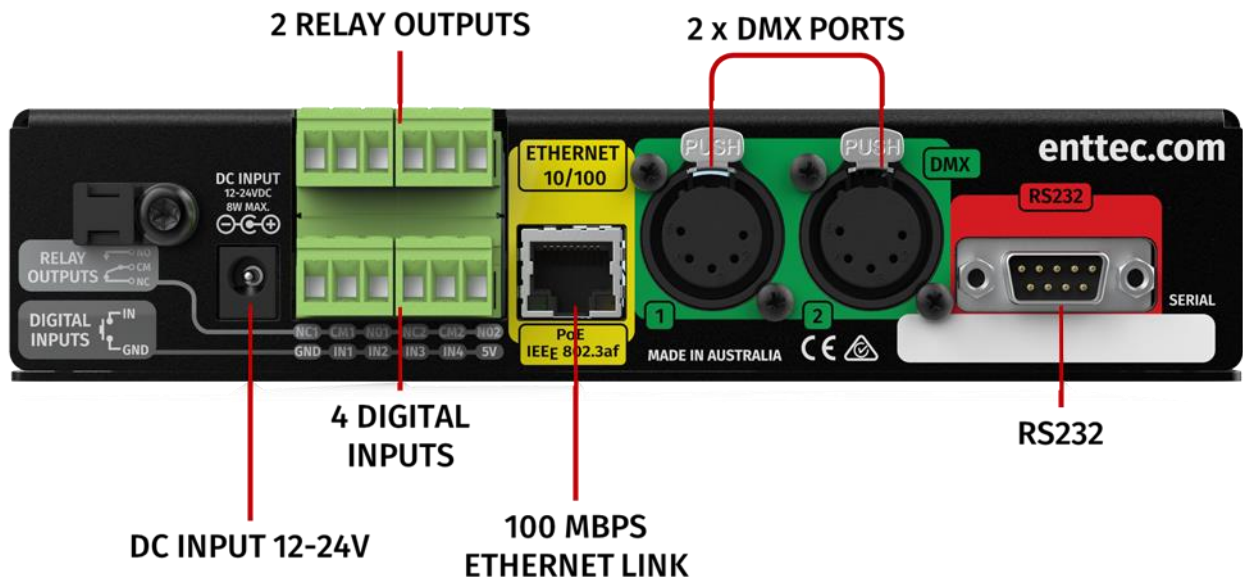

- 1U height – Half width
- Two bi-directional 5 Pin female DMX Ports
- Colour TFT LCD screen (160x128)
- Navigation LCD menu buttons
- 1 x USB Type A port
- 12 to 24v DC Input (8w max power draw) – Power supplies over 5A should not be connected to the S-PLAY.
- MicroSD card storage (Class 10 40/10 Mb/s Read/write performance)
- 100 Mbps Ethernet link featuring 802.3AF PoE
- 4 Digital Inputs (GPIO)
- 2 Relay outputs (NC, NO, COM)
- Solid-state design

S-PLAY Connectivity

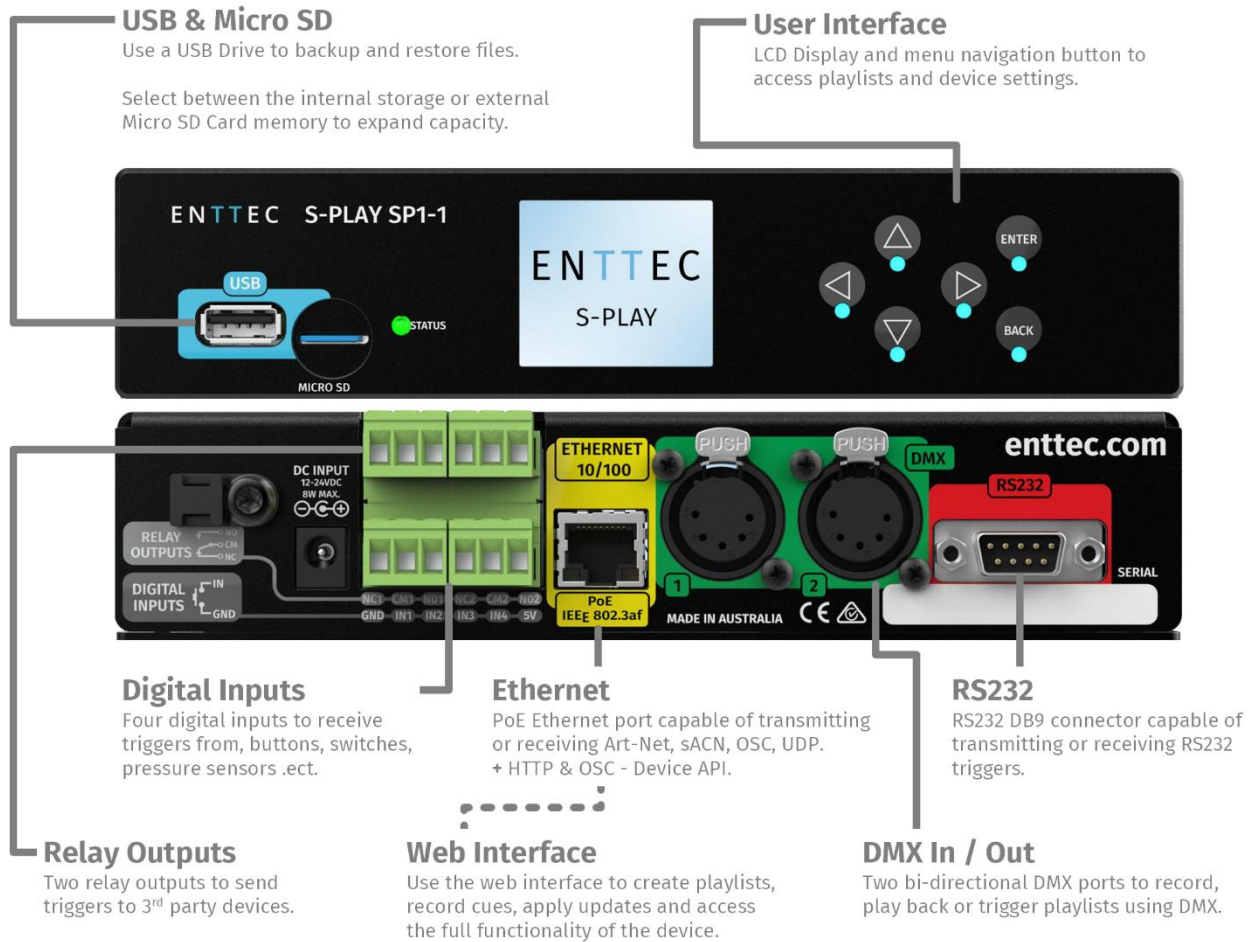

LCD Menu Screen

Controls

- **Direction arrows:** Use to navigate around menu tabs and increase or decrease the value in each field when selected. (i.e. IP address).
- **Back:** Use to return to the main menu from a sub-menu.
- **Enter:** Use to select and confirm actions within a menu or sub menu.



Home Screen

The Home Screen displays the following:

- Current date and time
- Device IP Address & Connection Status
- Device Name
- Playback state
- Lock Screen
- Play/Pause/Stop ALL
- Enable/Disable LCD backlight

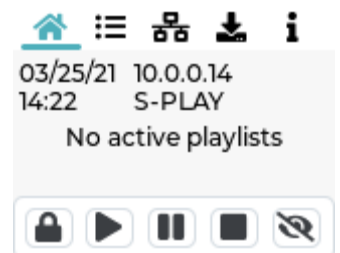

Playlist Menu

The Playlist Menu contains the following:

- View all playlists on the S-PLAY.
- Monitor playback status of all playlists.
- Play, Pause and Stop each playlist.

Navigate up and down the page using the arrow keys. Press 'enter' to select a playlist and once more to execute play / pause / stop commands.

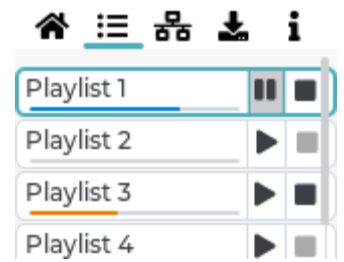

Network Menu

The Network Menu allows:

- DHCP to be Enabled / Disabled.
- Network connection status to be monitored.
- IP Address to be set.
- Network Mask to be set.
- Default Gateway to be set.

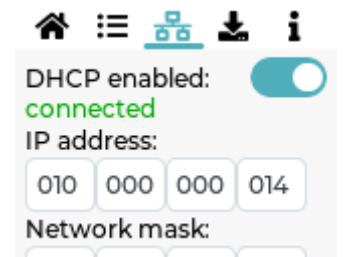

Utilities Menu

The Utilities menu allows:

- USB Backups to be performed.
- USB Backups to be restored.
- USB Firmware update.
- Reset to factory defaults (see section within this manual).



To create or restore a backup you must insert a USB thumb drive or SD card of 8GB capacity or more into the S-PLAY and ensure it is named 'backup.bak'.

The S-PLAY applies compression to all backup files. – If your S-PLAY contains large playlists and recordings (up to 8GB in size) this process may take up to 20 minutes to complete.

When updating S-PLAY firmware using a USB thumb drive, copy the latest firmware file from the ENTTEC website, onto the USB thumb drive and rename it to 'firmware.bin'. Insert it into the S-PLAY and select 'Firmware update'. Once the progress counter passes 70% the file has been copied across and validated.

Once the backup/restore process has been started, it's possible to navigate away from the process whilst it's still active by pressing "enter". After this process is completed, a popup will appear showing a completion message.

DO NOT remove the USB thumb drive whilst creating or restoring a backup.

Information Menu

The Information menu allows:

- The IP Address to be viewed.
- Firmware Version information to be viewed.
- CPU temperature.
- Up time (how long the S-PLAY has been powered on for) to be monitored.
- Device serial number to be viewed.

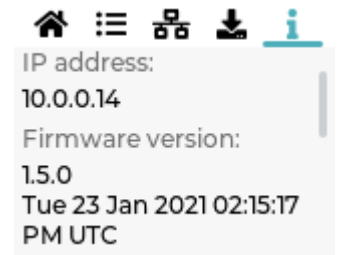

Out of the Box

Right out of the box, the S-PLAY is factory configured to:

- DHCP – Allowing you to plug it directly into your existing router and it will receive a network address.
- Output to DMX ports.
- Update its internal clock based on the NTP server to update the date and time based on the selected time zone.

To begin your installation please follow these steps:

- Unpack the unit from the box. Inspect the S-PLAY for any damage that might have occurred in shipping and verify that it looks to be in good condition before plugging it into power.
- S-PLAY occupies a half width 1RU space, you will need to attach the mounting bracket kit included in the box to use the S-PLAY within a half width rack.
- Using a Cat5, Cat5e or Cat6 cable, connect the S-PLAY to an ethernet network.
- If the unit is connected to a compatible PoE (IEEE 802.3af) router or switch skip this step. Otherwise, use the provided AC->DC power adapter to power up the unit by plugging it into your mains outlet and the rear of the S-PLAY.
- Once the unit is powered on, you will be able to see its IP address on the LCD display. The IP address will be automatically assigned by the network, if connected to a DHCP network. If you are connected to a static network, navigate to the devices settings to define a static IP address to allow you connect with the unit's web interface.

Network Discovery

To configure your S-PLAY you will be required to use its web interface, to find your S-PLAYS IP Address you can either:

View the S-PLAYs LCD

1. Ensure your S-PLAY is physically hooked up to your network (or WiFi router) using an ethernet cable – DHCP is recommended for first time use.
2. Power up the device.
3. Monitor the LCD menu. The LCD will display the IP address in the LCD home page. If your S-PLAY's LCD shows 'NO DHCP' change it to have a static IP under the network tab S-PLAY is set to the correct IP setting in the settings menu (either Static or DHCP) and power cycle the device.
4. Using a browser on a device within the same network range, type in the IP address shown on the LCD in order to access the web interface to load the S-PLAY web interface. All configuration can be undertaken using the devices web page.

Finding an S-PLAY's IP Address from NMU

ENTTEC provides free software (available for Windows and OSX) called Node Management Utility (NMU) that find the S-PLAY and display its IP address.

Note: The S-PLAY is only supported in NMU v1.93 and above, using an older version will .

Please follow these steps:

1. Download NMU from www.enttec.com.
2. S-PLAY should be connected physically by an ethernet cable to the same physical network (or router) as the computer on which you will run NMU.
3. Open NMU. If prompted to, select your computers network interface that your S-PLAY is connected to.
4. Press the Discovery button and wait until NMU finds all supported ENTTEC devices.
5. Once found, select 'S-PLAY' and press 'Configure' to be directed to your S-PLAYs Web interface.

Note: When the S-PLAY is set to a static IP, the default gateway **MUST** be the same for both the S-PLAY and your computer for NMU to discover the S-PLAY.

Changing the Network Settings

Changing the Network Settings Using LCD Interface

1. Use the up or down navigation buttons located next to the screen to move to the Network tab.
2. Toggle between DHCP and Static by pressing enter to change options.
3. Press the Enter button to select each field and confirm each field of the IP address.
4. Use the arrows to assign a value for each byte in IP; press on the right-left arrow to move in increments of 10, or use the up-down arrow to move in increments of one.
5. Once the desired IP is set, press enter button to move to Netmask settings.
6. Use the arrows to navigate to the SET button and press Enter.
7. All network settings assigned will get saved once the OK button is selected.

Change IP Using the Web Interface

Change the Network settings between DHCP and Static IP, Netmask and Gateway.

After modifying an IP address, it is good practice to power cycle the S-PLAY device.

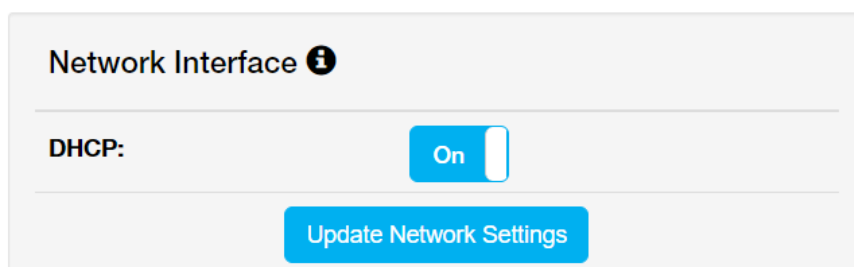

The screenshot shows a web interface for 'Network Interface' with an information icon. Below the title, there is a 'DHCP:' label followed by a blue toggle switch currently set to 'On'. At the bottom of the interface is a blue button labeled 'Update Network Settings'.

Network Interface ⓘ

DHCP: Off

IP Address: . . .

Net Mask: . . .

Gateway: . . .

[Update Network Settings](#)

Web interface

The S-PLAY can be configured and controlled through a web browser on a computer, located on the same Local Area Network (LAN) as the device. Either click on the 'configure button within in NMU or type the IP address (as detected by NMU e.g. 10.10.3.156) into your web browser to access the web interface.

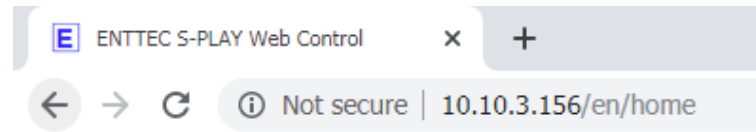

The S-PLAYs web interface consists of the following pages:

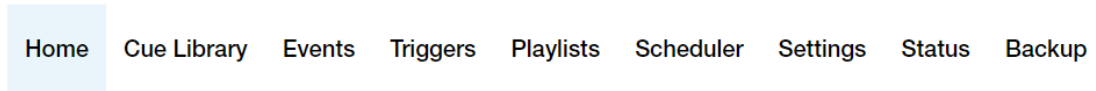

Home

The home page presents playlists and schedules to give an overview of all playback on the S-PLAY. This page is the default landing page of the S-PLAY,

When used in combination with the **lock** function, the homepage can be used to present end users of the system a page to view all playlists and schedules:

Playlists:

- Play, Pause, Stop, Intensity, Progress.

Schedules:

- Activate and Pause schedules

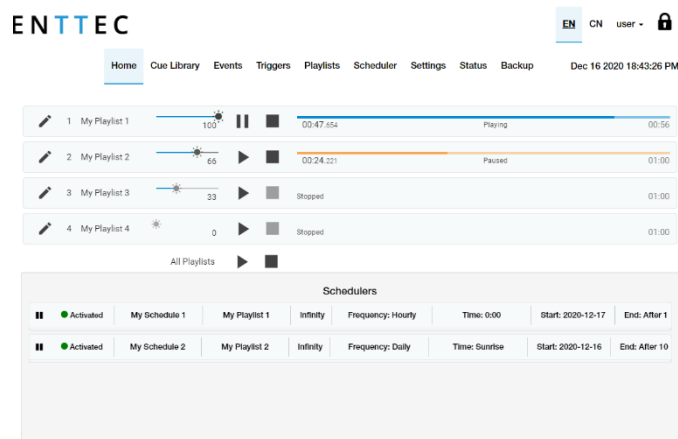

Note: Specific playlists can be hidden from the home page by selecting the '**Hide from Home**' option when editing each playlist on the playlist page.

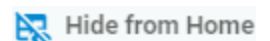

Cue Library

The Cue Library page allows:

- Cues to be created, configured, edited and recorded before building into a playlist.
- Cues to be previewed.

The S-PLAY's cue library is based around three key types of cue that can be created by using the green  icon:

- **Static Scene** is a single frame of between 1 -> 32 universes that can contain user defined DMX values or a snapshot of an incoming DMX frame (or mix of the two) that can be built into a playlist captured at a given time instance.
- **Dynamic Recording** is a recording of up to 32 universes of lighting control data. The S-PLAY provides various methods to allow a perfect loop to be achieved when recording over a user defined time period.
- An **Effect cue** is a cue type capable of creating internal effects from within the S-PLAY without requiring a DMX source (i.e. rainbow).

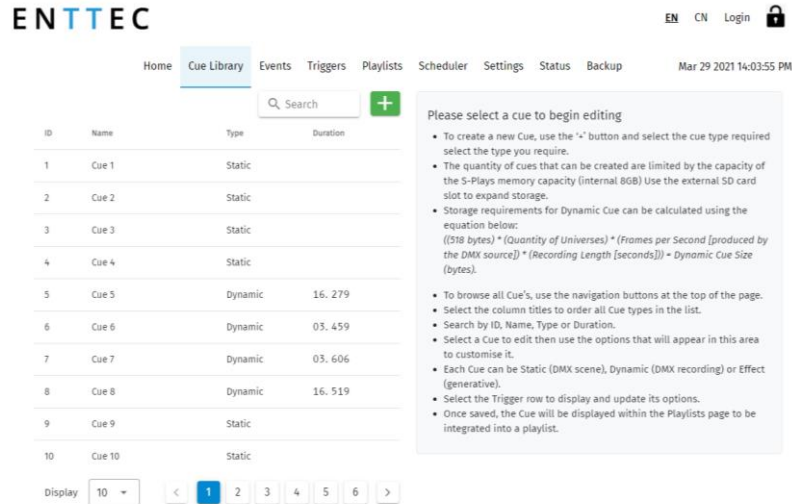

Once a cue is selected to be edited, the S-PLAY will internally trigger the **Stop All** command internally to stop all playback on the S-PLAY to stop overlapping.

Static Scenes

When creating a Static Scene, press the green **+** icon and select Static Scene as the cue type:

1. Provide a cue name to aid identification.
2. Set the cue type to 'Static Scene'.
3. Press the 'Edit Scene' button to open the editor window.

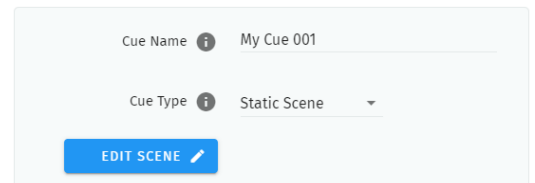

This window will allow values to be manually set or a snapshot to be taken of a live Art-Net / sACN / physical DMX input. Once this is taken the S-PLAY will populate the grid with DMX values that can be edited with the inbuilt tools. Alternatively, use the inbuilt tools to create a look from the S-Play natively.

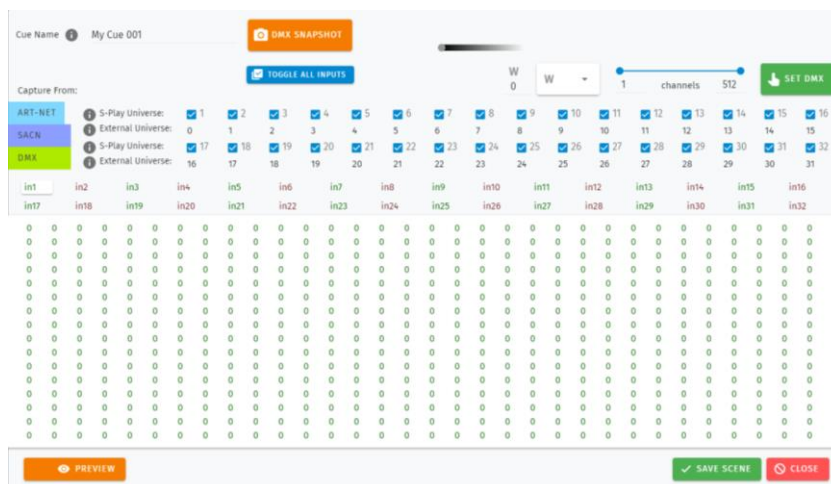

DMX Snapshot

To capture a DMX Snapshot, define the protocol and external universes you want to take the snapshot from (set all external universes to be identical if you want to mirror the same external Art-Net / sACN snapshot to all internal universes). By selecting one from the coloured menu of universes.

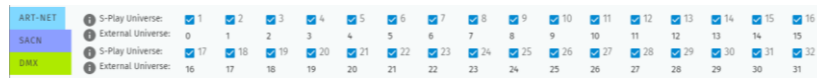

It's possible to record the following number of channels for each protocol:

- DMX (up to 2 Universes / 1024 Channels).
- Art-Net (up to 32 Universes / 16,384 Channels).
- sACN (up to 32 Universes / 16,384 Channels).

Once the option for capturing is selected (either manually defined or a live snapshot), press on the 'DMX Snapshot' button to take a snapshot of your input.

Cue Creation

Values can be modified and previewed with or without a DMX snapshot.

Use the S-PLAY's inbuilt editor to create looks and define DMX values manually using per channel values, the colour picker relevant to the fixture type by pressing 'SET DMX'.

Note: Values are applied to all selected S-Play universes when 'SET DMX' is pressed.

Toggle All Inputs: Selects / Deselects all input universes.

Preview: Observe the contents of the Cue. This will stop all other S-Play playbacks.

Stop Preview: Stop output of captured data through DMX ports.

Save Scene: Used to save the cue.

Close: Close edit window without saving.

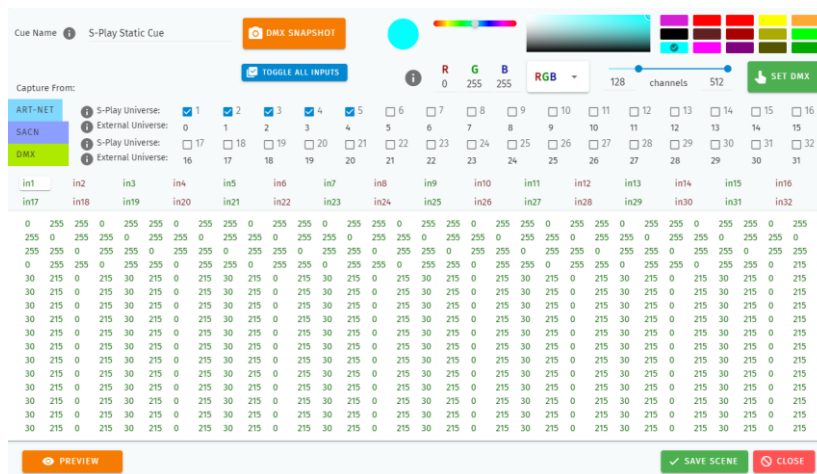

Dynamic Recordings

Dynamic Recordings allow DMX/ Art-Net/ sACN streams to be recorded and integrated into a show. To create a new Dynamic Cue

To create a new Dynamic Cue

Cues, select any cue in the library as shown in the image below.

When creating a Static Scene, press the green **+** icon and select Static Scene as the cue type:

1. Provide a cue name to aid identification.
2. Set the cue type to 'Dynamic Cue'.
3. Define a Recording Control to stop and start the recording.
4. Press the 'Edit Scene' button to open the editor window.

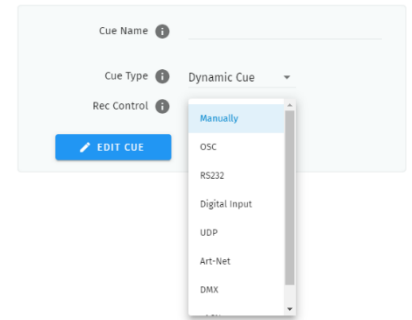

Recording Pointers:



During Art-Net or sACN recording if using the 'live preview' function, ensure that no other active Art-Net/sACN device is outputting on the same universes as being recorded to (including the S-PLAY). This will eliminate the chance of interference loopback that can lead to jumpy or incorrect recordings. – To modify your S-PLAYS output settings navigate to the Settings page.

When recording using the physical DMX ports, ensure the DMX ports are not already configured to be outputs on the Settings page. – If a DMX port is configured to be an output it will be unable to receive data.

Dynamic Recording Control

1. Enter a cue name to aid identification.
2. Select Dynamic Cue as the cue type.
3. Select '**Manually**' or choose a triggering option to start and stop the 'Rec. Control' dropdown.
4. Press the Edit Record button.
5. Select one of the following options for data capture:
 - a. DMX (up to 2 Universes / 1024 Channels)
 - b. Art-Net (up to 32 Universes / 16,384 Channels)
 - c. sACN (up to 32 Universes / 16,384 Channels)
6. Specify the universes and channel range for capturing data by toggling the checkboxes and modifying the input universe fields.
7. To send data being recorded to your fixtures to your outputs defined on the Settings page, toggle 'Live Preview' on.

Live Preview i
8. If recording looped content toggle 'Perfect Loop' on for the S-Play to stop recording when it detects a loop.

Perfect Loop i
9. Once the option for capturing is selected, press on the start rec button to start the recording or prime the S-Play ready to receive the start trigger if one was defined.
 - The timer in the top right of the window will start running as soon as data begins to be captured.

The DMX values captured will be shown for their corresponding universes.

Effects

1. A slot from the Cue Library.
2. Provide cue name to aid identification.
3. Select Effect from the **Cue Type** dropdown.
4. Press the **Edit Effect** button.

5. Configure your desired effects using the onboard parameters. – The S-PLAYs colour effects have been primarily designed around LED and RGBW fixtures.

6. Effects are applied on a per universe basis and do not cascade across multiple. – Select each S-PLAY universe that you wish to apply the effect to.
7. After the parameters have been set, the S-PLAY allows effects to be previewed using the **Preview** button.
8. Once happy with the effect created this can be saved to the S-PLAYs memory.

Preview Cue

- Select a Cue within the Cue Library and enter edit mode.
- Click Preview Cue.
- The Cue is previewed on the selected output ports as defined within the S-PLAY's Settings page.
- When previewing a cue, be sure to stop the preview when done.

Editing a Cue, Effect or Dynamic Recording

After a cue has been created, the option to edit it is available when selecting the cue in the Cue Library, please note this directly overwrites the full universe values received and extends the length of the cue if necessary.

If you wish to subtract elements from a static scene, effect or dynamic recording (i.e. remove universes or individual channels from the recording, shorten the length of a dynamic cue), this cannot be done using the edit function. Clear the scene and start again with a new cue.

Events

The Events page allows:

- Create custom Relay, UDP, OSC, RS232, DMX, Art-Net and sACN Events, ready to be embedded in playlists.
- Editing, testing and deletion of Events.

Use events to allow integration between S-PLAY and other devices. The S-PLAY can send commands over multiple protocols and interact with Relays.

ENTTEC

EN CN Login

Home Cue Library **Events** Triggers Playlists Scheduler Settings Status Backup Nov 12 2019 16:01:11 PM

Show 20 Controls

ID	Name	Protocol
1	Event 000	N/A
2	Event 001	N/A
3	Event 002	N/A
4	Event 003	N/A

Events are commands that are sent from S-Play using the desired protocol.

- 128 Events entries to configure
- To see more events, use the navigation buttons on the bottom of the page
- Click the name of the column to sort the list
- Search by event name, protocol type or event ID
- Click on the event row to display options
- Once saved, you can use the events in the Playlist Page.

RS232

- An RS232 Event will send the user defined RS232 command, when activated.
- RS232 strings ending in `\r` – the `\r` will be replaced by a carriage return.
- RS232 strings ending in `\n` – the `\n` will be replaced by a line feed.

Make sure the receiver has the correct communication setup:

- Baud rate: 9600
- Data: 8bit
- Parity: None
- Stop: 1bit
- Flow Control: none

Note: ASCII Command text limited to 1024 Characters.

Event Name RS232 Event

Output Type RS232

- An RS232 Event will send the user defined RS232 command, when activated.
- **RS232 communication information** Baud rate: 9600, Data: 8 bit, Parity: none, Stop: 1 bit, Flow Control: none.
- Commands are limited to 32 characters.
- RS232 strings ending in: `\r` – the `\r` will be replaced by a carriage return. `\n` – the `\n` will be replaced by a line feed.

Command

SEND EVENT

SAVE EVENT

UDP

- A UDP Event will send the command defined below when activated.
- Commands are limited to 1024 characters.
- UDP strings ending in `\r` – the `\r` will be replaced by a carriage return.
- UDP strings ending in `\n` – the `\n` will be replaced by a line feed.

Event Name UDP Event

Output Type UDP

- A UDP Event will send the command defined below when activated.
- Commands are limited to 1024 characters.
- UDP strings ending in: `\r` – the `\r` will be replaced by a carriage return. `\n` – the `\n` will be replaced by a line feed.

IP 10 0 0 255

Port

Command

SEND EVENT

SAVE EVENT

OSC

- When activated, this Event will send the OSC data defined in the settings.
- OSC Strings, Floats and Integers can be defined.
- All OSC address must start with a leading '/' sign.

Relay

Control the relay action.

- NO: Normally Open
- NC: Normally Closed

When activated in a playlist the Relay will perform the selected action.

Note: On system power-up, the Relays position is set to be normally open.

Art-Net

When activated, this Event will send the Art-Net channel defined in the settings defined.

- For best practice, do not overlap Events with universes used for playback of recordings.

sACN

When activated, this Event will send the sACN channel defined in the settings.

- For best practice, do not overlap Events with universes used for playback of recordings.

Event Name ⓘ sACN Event

Output Type ⓘ sACN

• When activated, this Event will send the sACN channel defined in the settings below.

Multicast IP ⓘ 239 255 0 1

sACN Universe ⓘ 1

sACN Channel ⓘ 1

Channel Level ⓘ 0

[▶ SEND EVENT](#)

[📄 SAVE EVENT](#)

DMX

When activated, this Event will send the DMX channel defined in the settings.

- For best practice, do not overlap Events with universes used for playback of recordings.

Event Name ⓘ DMX Event

Output Type ⓘ DMX

• When activated, this Event will send the DMX channel defined in the settings below.

DMX Port ⓘ Port 1

DMX Channel ⓘ 1

Channel Level ⓘ 0

[▶ SEND EVENT](#)

[📄 SAVE EVENT](#)

Triggers

The Triggers page allows:

- Create custom Digital input, UDP, OSC, RS232, DMX, Art-Net and sACN Triggers, ready to be embedded in or trigger playlists.
- Editing, testing and deletion of Triggers.

ENTTEC

EN CN Login

Home Cue Library Events **Triggers** Playlists Scheduler Settings Status Backup May 27 2020 16:57:25 PM

Show 20 Controls

ID	Name	Protocol
1	Trigger 000	N/A
2	Trigger 001	N/A
3	Trigger 002	N/A
4	Trigger 003	N/A

Triggers are commands that the S-PLAY will wait for before activating a playlist.

- A list of 128 Triggers allowing for configuration
- To see more triggers, use the navigation buttons at the bottom of the page or increase the quantity displayed per page.
- Click the name of the column to sort the list
- Search by trigger name, protocol type or trigger ID
- Click on the trigger row to display options
- Once saved, you can use the trigger in the Playlist Page.

Use triggers to take control of the timeline of the playlist. When using a trigger, the timeline will pause until the selected trigger is active.

Triggers can be used to start a playlist or at any point within the timeline.

When a playlist is waiting for a trigger, it will play by either activating the trigger or by pressing play. This way there is full control of the playback even when the triggers are not available.

When creating new triggers, the 'Test Trigger' option can be used to send the trigger being created.

RS232

RS232 communication settings:

- Baud Rate: 9600
- Data: 8bits
- Parity: none
- Stop: 1bit
- Flow Control: None

Note: Each command string is limited to 1024 Characters.

Trigger Name RS232 Trigger

Input Type RS232

• A Trigger will be activated when an incoming command matches the user defined RS232 command.

Command

TEST TRIGGER

SAVE TRIGGER

UDP

UDP communication settings:

- A Trigger will be activated when an incoming UDP command matches the one defined below.
- When used in a playlist, the S-PLAY will wait to receive the Trigger below before continuing.
- To define a UDP input port navigate to your S-PLAY's Settings page.
- UDP strings ending in: \r – the \r will be replaced by a carriage return. \n – the \n will be replaced by a line feed.

OSC

The S-PLAY can receive OSC through two key methods:

1. Triggers that can be created to start and resume playlists.
 - A Trigger will be activated when an incoming command matches the user defined Trigger string.
 - The command must be received upon the port defined within the settings page (default 8000).
 - All OSC commands must start with a leading '/' sign.
 - When used in a playlist, the S-PLAY will wait to receive the Trigger below before continuing.
2. Integration with the S-PLAYs OSC API to enable control of:
 - Master intensity
 - Play, pause and stop all playlists
 - Play, pause and stop individual playlists
 - Per-PLAYlist intensity control

Visit www.enttec.com to download a copy of the OSC API.

Digital Input

S-PLAY has 4 Digital input ports to activate triggers.

- Idle position for digitals input is high.
- A Trigger is registered when the circuit is completed (low).
- When used in a playlist, the S-PLAY will wait to receive the Trigger below before continuing.
- If the input remains on low position while the timeline goes over the trigger, the playlist won't pause.

Use Digital inputs with sensors, pressure pads, wall switches, etc.

Art-Net

An Art-Net trigger can be unicast or broadcast to the S-PLAY.

- The Trigger will be activated, when the incoming value is equal or greater than the Art-Net channel parameters defined.
- To avoid clashes do not use a universe assigned for Recording/Playback.
- When used in a playlist, the S-PLAY will wait to receive the Trigger below before continuing.

sACN

- The Trigger will be activated, when the incoming value is matched to the sACN channel parameters defined.
- To avoid clashes do not use a universe assigned for Recording/Playback.
- When used in a playlist, the S-PLAY will wait to receive the Trigger below before continuing.

DMX

- The Trigger will be activated, when the incoming value is matched to the DMX settings defined.
- To avoid clashes do not use a universe assigned for Recording/Playback.
- When used in a playlist, the S-PLAY will wait to receive the Trigger below before continuing.

Note: If DMX is selected as output protocol in the setting page, the DMX triggers will be disabled in the playlist.

Playlists

The Playlists page is where playlists can be created by combining Cues, Events and Triggers onto the timeline. Using the tools made available it is possible to:

- Create, Edit, Rename and Delete Playlists.
- Access to all Playlists.
- Play, Pause and Stop Playlists.
- Re-order Playlists.
- Hide certain playlists from the home page.
- Define loops.
- Define fade time.
- Define start and stop triggers or to start from start up.

ENTTEC

EN CN Login

Home Cue Library Events Triggers **Playlists** Scheduler Settings Status Backup Dec 17 2020 10:20:37 AM

All Playlists

Q Search

Static cue
Dynamic cue
Effects
Events
Triggers

0.000 01:00.000 0.000

Name

Start Trigger: No Trigger

Stop Trigger: No Trigger

Play Count: Infinity

Internal Priority: 100

Hide from Home

Group: 0

00:00 05 10 15 20 25 30 35 40 45 50 55 01

100

100

100

100

Events

Triggers

© 2020 ENTTEC | [Enttec Web](#) | [Contact us](#)

The playlist page allows the user to add multiple cues (static or dynamic), events and triggers in a sequence to be stored and played back at any given point.

Playlists Page Layout

The screenshot shows the ENTTEC web interface for the Playlists page. At the top, there is a navigation menu with options: Home, Cue Library, Events, Triggers, **Playlists** (highlighted), Scheduler, Settings, Status, and Backup. The current date and time are shown as Dec 17 2020 10:20:37 AM. On the right, there are language options (EN, CN) and a login button with a lock icon.

The main content area is divided into several sections:

- A:** A large empty box representing the list of created playlists.
- B:** A control bar for 'All Playlists' with play and stop buttons.
- C:** A search and filter bar with a search icon and buttons for 'Static cue', 'Dynamic cue', 'Effects', 'Events', and 'Triggers'.
- D:** A detailed view of a playlist attribute, showing fields for Name, Start Trigger (No Trigger), Stop Trigger (No Trigger), Play Count (Infinity), Internal Priority (100), Hide from Home, and Group (0).
- E:** A control bar for a specific playlist with fade in and fade out sliders.
- F:** A timeline navigation bar with zoom in (+) and zoom out (-) icons, and play, stop, and save icons.
- G:** Media Track Timelines, showing four tracks with a volume knob set to 100.
- H:** Event Track, showing a track labeled 'Events'.
- I:** Trigger Track, showing a track labeled 'Triggers'.

At the bottom of the page, there is a footer with the text: © 2020 ENTTEC | [Enttec Web](#) | [Contact us](#)

The playlists page is comprised of 9 key elements:

- A. Created Playlists (all playlists are shown here)
- B. Global Playlist Control
- C. Search and Filter Bar
- D. Attribute Library
- E. E. Playlist Attributes
- F. Timeline Navigation
- G. Media Track Timelines
- H. Event Track
- I. Trigger Track

Created Playlists

This section lists all the playlist created. The section displays basic information like the playlist name and duration and gives basic control over a playlist.

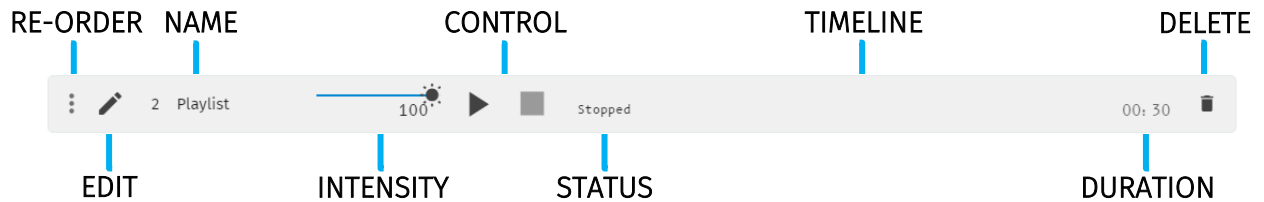

Reorder: Drag and drop the playlist from the three dots rearranging your playlist (this will be reflected on the Home Page).

Edit: Loads the playlist in the timeline and media tracks for editing

Name: Displays the ID (set internally) and name of the playlist set in the Playlist Attribute section.

Intensity: real-time control of the master intensity of the playlist. By default, it is set to 100% and it can be changed when the playlist is playing.

Control - Play: Play the selected playlist, also the Playlist is loaded into the timeline and media track section.

Control - Pause: Pause the selected playlist. By pausing a playlist, S-PLAY holds the last DMX value.

Control - Stop: Stops the selected playlist. By stopping a playlist, S-PLAY stops outputting any data (set DMX value to 0).

Status: Shows the status of the playlist. It can be: Playing, Paused, Stopped, Waiting for Trigger.

Timeline and Duration: Shows the playback state of each playlist. Once the playlist has completed playing, it stops outputting data. Opacity of this bar matches the playlist intensity.

Delete: Deletes the playlist and schedules where the playlist is used in

Global Playlist Control

Gives control over all playlists. When pressing play on the global control, all the playlists start playing. If there are conflicts in channels, the values are merged on a Highest Takes Precedence (HTP) basis.

Search and Filter Bar

This box contains all Cues Events and Triggers Stored on the S-PLAY. To create a new Playlist, select "Create New Playlist" from the list. This entry will always be the first entry of the menu.

Available Cues and Controls

Lists all the media that can be used in the playlist. It is categorized by Static Cues, Dynamic Cues, Effects, Events and Triggers.

To use any media, drag and drop the desired cue into any of the media tracks. Please note that triggers and events have dedicated tracks.

Playlist Attributes

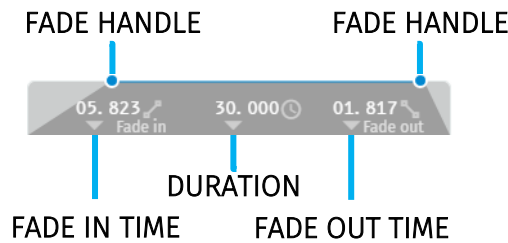
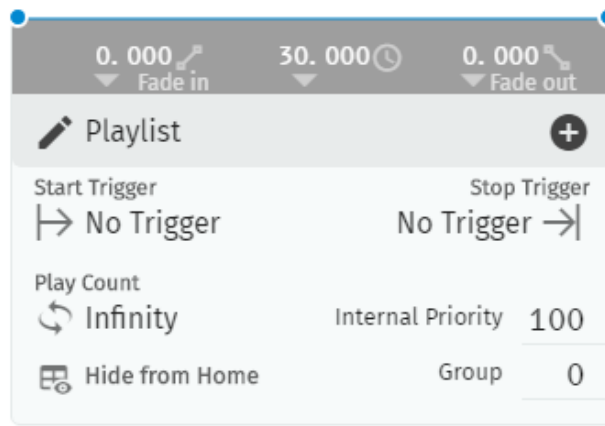

Name: Set the name of the playlist.

Internal Priority: When playing multiple playlists, for any conflict between channels, the playlist with higher priority will drive the output. If the playlist has the same priority the channels will merge following HTP (Highest takes precedence) method.

Loop: Determine the number of times that the playlist will play until it stops

Group: Define a group of playlists to override the output. Groups with the highest hierarchy drive the S-PLAY's output when the groups of the same number have universe conflicts the S-PLAY references Internal Priority.

Start Trigger: A list of triggers set in Triggers page, except "On Power Up" which triggers playlist right after Splay is powered on. These triggers are used to start the playlist. To use this feature, select a Trigger from the dropdown menu; the Playlist will play by either pressing play or activating the trigger.

Stop Trigger: A list of Triggers set in Triggers page. These triggers are used to stop the playlist. To use this feature, select a Trigger from the dropdown menu; the Playlist will stop when the trigger conditions are met.

Fade: Set the fade in and fade out time for a cue. It will go from 0 to max intensity in the set period.

Playlist Settings

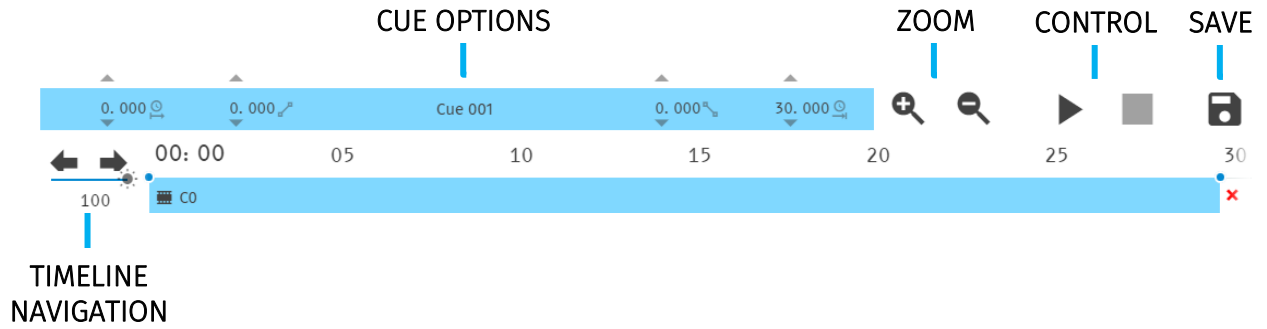

Cue Options: Options for any cue added into the cue track. The cue options are also active when a cue in the cue track is selected.

Zoom: Zoom In and Out using the magnifying glass with the plus and minus symbol. Note that when you zoom in/out, the values in the timeline change and the size of the cue boxes change.

Control: Gives navigation and playback over the playlist loaded in the Playlist Editor.

Save: Saves any change on the Playlist. S-PLAY will ask to save any change before playing a Playlist.

Timeline navigation: Navigate back and forward between timelines using this option. Drag the timeline to navigate back and forward.

Playlist Timeline and Media Tracks

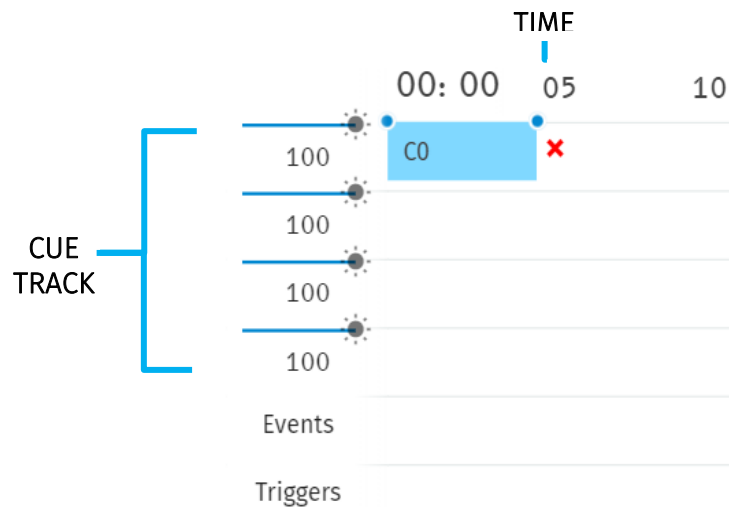

S-PLAY has 4 different cue tracks where any cue from the playlist media section can be dragged on.

Intensity: Each track has its own intensity and it affects all the media on the same level.

Cue tracks: Drag and drop media to this section. To remove a cue from the tracks, select the cue and click on the red **x** next to the right edge of the box.

When playing multiple media at the same time. i.e. 2 cues on 2 different tracks, S-PLAY will use HTP (Highest value Takes Priority) merging.

Event and Trigger Tracks

These tracks are reserved for events and triggers respectively. The vertical line shows the exact moment playlist will pause to wait for the trigger to be active, or the playlist executes the event. When using triggers, the playlist pauses and holds the last value on the output. To continue, activate the selected trigger or press play again.

Example Playlist

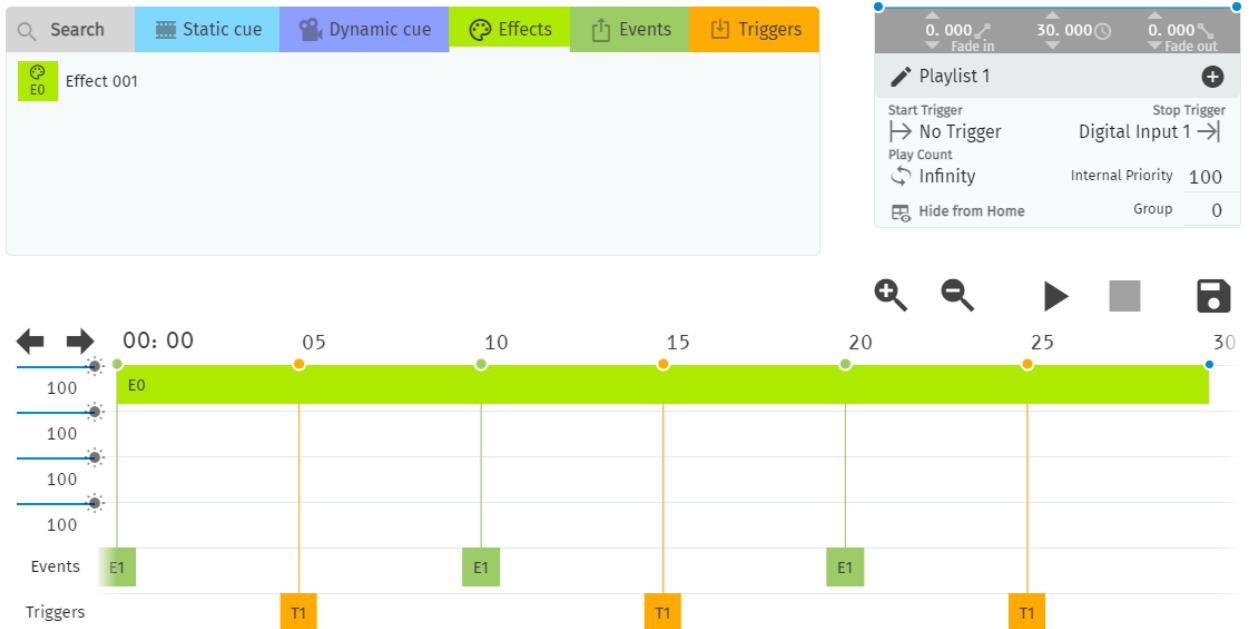

This example is showing a playlist named "Playlist 1" that will start on power up and will loop until manually stopped (Play Count: Infinity).

The effect cue "Cue 001" will play while sending an RS232 Event. By second 5 the playlist will pause and wait for the Digital input trigger to be sent before the effect will continue playing. The playlist will then continue sending Events and waiting for triggers. At second 30 it will loop back sending the first RS232 Event out.

Scheduler

The scheduler page allows the user to:

- Access all schedules
- Play and pause schedules
- Monitor status of the schedule
- Create and edit schedules

The screenshot displays the ENTTEC Scheduler interface. At the top, the ENTTEC logo is on the left, and user information (EN, CN, Login) and a lock icon are on the right. A navigation bar includes links for Home, Cue Library, Events, Triggers, Playlists, Scheduler (highlighted), Settings, Status, and Backup. The current date and time are shown as Dec 18 2020 10:57:14 AM. The main content area shows a message: "No Registered Schedules". Below this is a "Create New Scheduler" form. The form includes a "Schedule Name" field with the placeholder "New Name here...". It has a "Select Playlist" dropdown menu, a "Loop" field set to 4, and a "Command" dropdown set to "Play". The "Start" field is set to "2020-12-18" and the "Time" field is set to "0:00". The "End" field is also set to "2020-12-18". There are radio buttons for "After" (set to 1) and "Repetitions". The "Frequency Type" section has radio buttons for "Per Second", "Per Minute", "Hourly" (selected), "Daily", "Weekly", "Monthly", "Yearly", and "Astronomical". A text input field shows "Every 1 Hour(s)". At the bottom of the form are "Save Scheduler" and "Delete" buttons. A footer bar contains the text "© 2020 ENTTEC | Enttec Web | Contact us".

To set up a schedule you need to create a playlist first. The scheduler will play the playlist at a set time until the end condition is met. i.e. PlaylistA can be played every day on sunset from the 1st of February until the last Friday of October.

The playlists played by the scheduler will play after the current playlist is met. For example, in the previous example, if the S-Play is playing PlaylistB right before sunset, S-PLAY will wait for PlaylistB to complete before playing PlaylistA set in the scheduler.

Always ensure your S-Play system time and location is set correctly when using schedulers.

The page has 7 different sections:

- A. Created Schedules.
- B. List of Schedules.
- C. Schedule name.
- D. Selected playlist.
- E. Start condition.
- F. End condition.
- G. Frequency type.

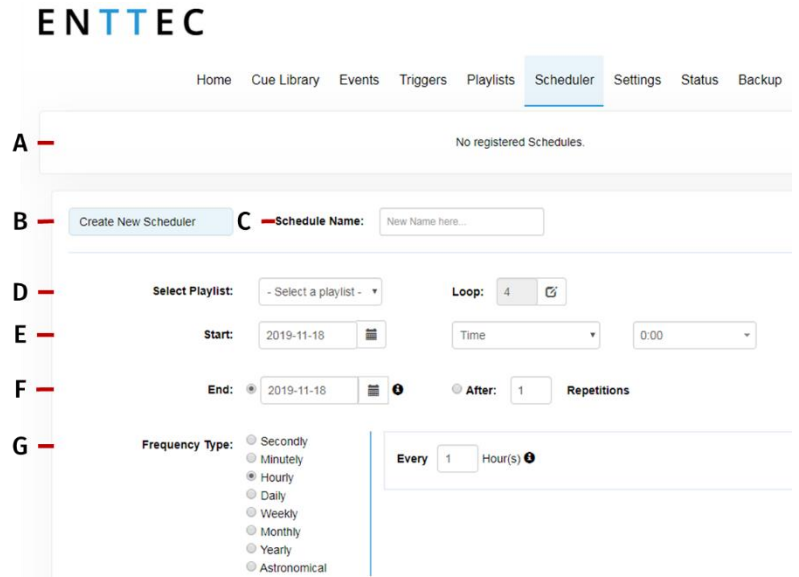

Created Schedules

The created schedulers list gives information at a glance of the parameters set on each scheduler.

Pause/Play: Gives control of the scheduler. If a scheduler is paused, the status light will become yellow.

Load: Load scheduler into the Scheduler Editor to update or change any parameter.

Status: Displays the status of the scheduler.

- Green: Active Scheduler. An active scheduler still has instances to play.
- Red: Expired Scheduler. An expired scheduler does not have any instances left to play.
- Yellow: Paused Scheduler. The scheduler will not play until it's active and the end condition is not met.

Scheduler name: Name set in the scheduler editor.

Playlist name: Playlist selected in the scheduler editor.

Play Count: Play Count is set in the scheduler editor, by default this is the same value configured in the playlist attributes.

Scheduler frequency: frequency set in the scheduler editor.

Start time: Time set in the scheduler editor.

Start date: Start date set in the scheduler editor.

End condition: End condition set in the scheduler editor. To set an infinitely looping schedule, set the end time to be identical to the beginning.

Delete: Delete selected scheduler.

List of Schedules

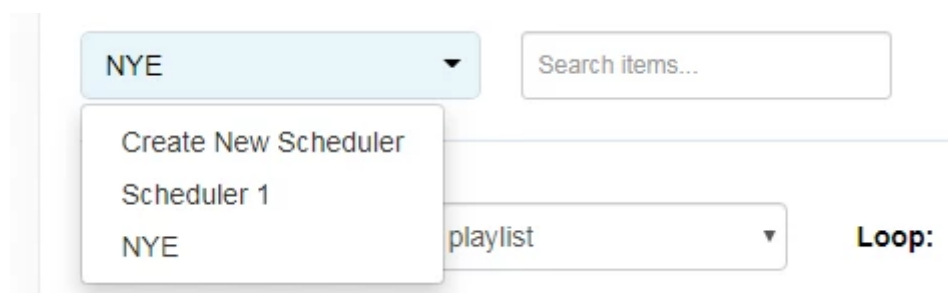

Lists all the schedules saved and shown in the created scheduler section. When an option is selected, its

parameters are loaded into the scheduler editor.

To create a new scheduler, select "Create New Scheduler" option.

Schedule Name

Name to aid Schedule identification.

Selected Playlist

List of available Playlist to be scheduled.

Start Condition

Set a schedule to start at a specific time, at sunrise or sunset. The sun phase is calculated based on the location set in the settings page. It takes into consideration:

- GMT Offset.
- Latitude.
- Longitude.

To set the start of the scheduler to a specific time do the following:

- Select "Time" from the dropdown menu.
- Click the first two digits on the second dropdown menu and set the hour using the dial. Note that the inner circle shows hours past noon (>12) and the outer circle show hours before noon (1AM to 12).

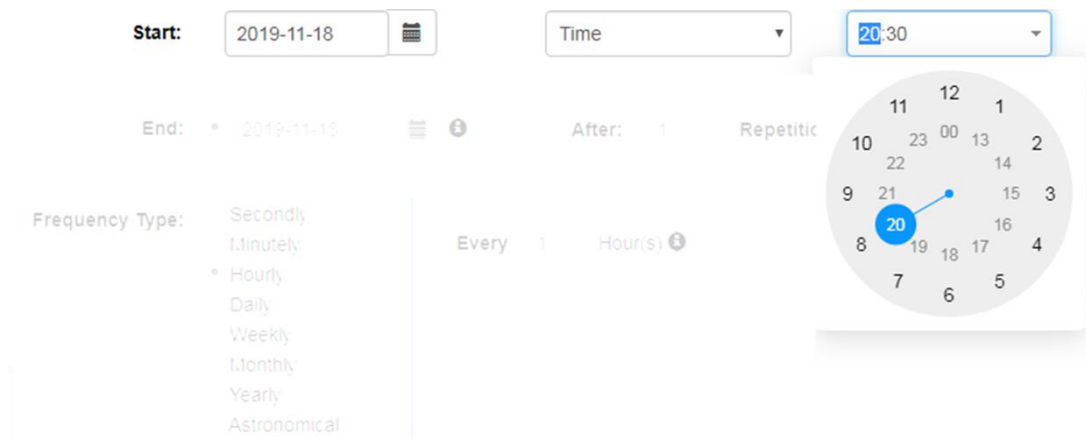

- To set the minutes, click on the last two digits and use the dial to select the desired time.

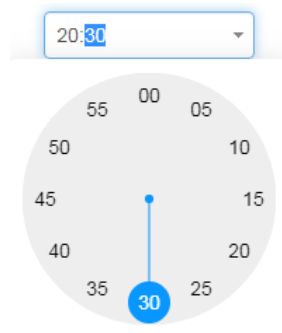

End Condition

The scheduler will be expired once the end condition is met. It can be on a specific date or after a desired number of repetitions.

Frequency Type

Set the frequency when the playlist set will play.

Frequency Type:

- Per Second
- Per Minute
- Hourly
- Daily
- Weekly
- Monthly
- Yearly
- Astronomical

Every Second(s) ⓘ

Save Scheduler
Delete

Per Second: Start the selected playlist after the specified seconds.

Per Minute: Start the selected playlist after the specified minutes.

Hourly: Start the selected playlist after the specified hours.

Daily: Start the selected playlist either every day or every number of days specified.

Frequency Type:

- Per Second
- Per Minute
- Hourly
- Daily
- Weekly
- Monthly
- Yearly
- Astronomical

Every Day

Every **days**

Save Scheduler
Delete

Weekly: The selected playlist will play on the selected days every week or as specified in the text box. In the example, the playlist will play every week on Wednesdays and Tuesdays.

Frequency Type:

- Per Second
- Per Minute
- Hourly
- Daily
- Weekly
- Monthly
- Yearly
- Astronomical

<input type="checkbox"/> Monday	<input type="checkbox"/> Tuesday
<input type="checkbox"/> Wednesday	<input type="checkbox"/> Thursday
<input type="checkbox"/> Friday	<input type="checkbox"/> Saturday
<input type="checkbox"/> Sunday	

Monthly: The selected playlist will play a specific day of every month as specified. In the example above, the playlist will play the 1st Day of every month.

- Frequency Type:**
- Per Second
 - Per Minute
 - Hourly
 - Daily
 - Weekly
 - Monthly
 - Yearly
 - Astronomical

- Day of every month
- The of every month

Yearly: The selected playlist will play a specific day of the year. In the example above, the playlist will play every year on the 1st of January.

- Frequency Type:**
- Per Second
 - Per Minute
 - Hourly
 - Daily
 - Weekly
 - Monthly
 - Yearly
 - Astronomical

- The
- On the of

Astronomical: The selected playlist will play depending on the phase of the moon. In the example above, the playlist will play every new moon.

- Frequency Type:**
- Per Second
 - Per Minute
 - Hourly
 - Daily
 - Weekly
 - Monthly
 - Yearly
 - Astronomical

- New Moon
- First Quarter
- Full Moon
- Third Quarter

Settings

The settings page allows the user to:

- Configure Art-Net and sACN output universes and destination IP's
- Configure output protocol refresh rate
- Configure DMX output ports
- Define the OSC and UDP input port
- Set the date, time and location
- Change the S-PLAY's network configuration
- Configure remote access using SSH Tunnelling (Advanced Feature).
- Reset to factory defaults
- Update firmware



Note: Do not downgrade firmware version without consulting the ENTTEC support team first. Downgrading, firmware version may result in playlists, schedules to operate as intended.



S-PLAY Outputs
Default Configurations

Universe 1: ArtNet 1	Universe 2: ArtNet 2	Universe 3: ArtNet 3	Universe 4: ArtNet 4
Universe 5: ArtNet 5	Universe 6: ArtNet 6	Universe 7: ArtNet 7	Universe 8: ArtNet 8
Universe 9: ArtNet 9	Universe 10: ArtNet 10	Universe 11: ArtNet 11	Universe 12: ArtNet 12
Universe 13: ArtNet 13	Universe 14: ArtNet 14	Universe 15: ArtNet 15	Universe 16: ArtNet 16
Universe 17: ArtNet 17	Universe 18: ArtNet 18	Universe 19: ArtNet 19	Universe 20: ArtNet 20
Universe 21: ArtNet 21	Universe 22: ArtNet 22	Universe 23: ArtNet 23	Universe 24: ArtNet 24
Universe 25: ArtNet 25	Universe 26: ArtNet 26	Universe 27: ArtNet 27	Universe 28: ArtNet 28
Universe 29: ArtNet 29	Universe 30: ArtNet 30	Universe 31: ArtNet 31	Universe 32: ArtNet 32

[Update Outputs](#)

ArtNet

[Configure Art Net](#)

sACN

[Configure sACN](#)

DMX Output

Refresh Rate: fps

[Update DMX Settings](#)

Network Input Ports

OSC Input Port:

UDP Input Port:

[Update Network Input Settings](#)

Date & Time

Set Date Manually:

Date: 2021

Time: :

Time Zone:

[Update Clock](#)

Network Interface

DHCP:

[Update Network Settings](#)

Location

GMT offset: Hrs: Min:

Latitude:

Longitude:

Calculated: Sunrise: 08:26 Sunset: 17:29

[Update Location](#)

Remote Access

Enable:

IP: . . .

Remote Port: <http://0.0.0.0:8080>

Username:

SSH Key:

[Update Remote Access Settings](#)

Reset to Factory Defaults

Click **RESET TO FACTORY DEFAULTS** to clear all user-entered configuration and reset this S-Play to factory defaults. After resetting, the:

- Web Passwords will return to their default setting
- The IP address will be set to DHCP
- All cues, playlists events and triggers will be wiped.

Warning: Factory resetting this device is irreversible and will wipe all data previously entered on this device.

[Reset to factory defaults](#)

Firmware Update

Note: Do not downgrade firmware version without consulting the ENTTEC support team first. Downgrading, firmware version may result in playlists, schedules, events and triggers not operating as intended. Always perform a backup before updating firmware version.

Upload New Firmware:

S-PLAY Output

Change outputs independently between Art-Net, sACN and DMX.

S-PLAY Outputs All Artnet ▾

Universe 1: DMX Port 1 ▾	Universe 2: DMX Port 2 ▾	Universe 3: ArtNet 3 ▾	Universe 4: ArtNet 4 ▾
Universe 5: ArtNet 5 ▾	Universe 6: ArtNet 6 ▾	Universe 7: ArtNet 7 ▾	Universe 8: ArtNet 8 ▾
Universe 9: ArtNet 9 ▾	Universe 10: ArtNet 10 ▾	Universe 11: ArtNet 11 ▾	Universe 12: ArtNet 12 ▾
Universe 13: ArtNet 13 ▾	Universe 14: ArtNet 14 ▾	Universe 15: ArtNet 15 ▾	Universe 16: ArtNet 16 ▾
Universe 17: ArtNet 17 ▾	Universe 18: ArtNet 18 ▾	Universe 19: ArtNet 19 ▾	Universe 20: ArtNet 20 ▾
Universe 21: ArtNet 21 ▾	Universe 22: ArtNet 22 ▾	Universe 23: ArtNet 23 ▾	Universe 24: ArtNet 24 ▾
Universe 25: sACN 1 ▾	Universe 26: sACN 2 ▾	Universe 27: sACN 3 ▾	Universe 28: sACN 4 ▾
Universe 29: None ▾	Universe 30: None ▾	Universe 31: None ▾	Universe 32: None ▾

[↻ Update Outputs](#)

Use the Default configurations option in the top part of the section to Select between Art-Net, sACN, DMX or No Output.

Art-Net Output Configuration

- Configure output refresh rate for all Art-Net output stream.
- Set output Art-Net each of the 32 universes
 - Universe
 - Unicast IP address
 - Broadcast
- Save after any change by pressing "Update Art-Net".

Note: Max refresh rate = 60FPS.

Art-Net ⓘ

Refresh Rate: 44 fps

Output:

ArtNet 1: 0 Net:0 Subnet:0 Universe:0

Unicast **IP:** 192 . 168 . 0 . 1

[🔄 Update Art-Net](#)

SUCCESS. Art-Net updated successfully. ✕

sACN output configuration

- Configure output refresh rate for all sACN output stream
- Set output sACN each of the 32 universes
 - Universe
 - Unicast IP address
 - multicast
- Save after any change by pressing "Update sACN"
- Generate sACN ID
- Set S-PLAY sACN priority

Note: Max refresh rate=60FPS

Change Date/Time and Location

Set time, date and location. This information is critical when setting schedules.

When the Set Date Manually is off and the S-PLAY is connected to an NTP server, the S-PLAY will automatically update the system time information upon power-up.

If the S-PLAY's system time is set manually the S-PLAY will stay locked to a set time. The user must manually update the time to reflect daylight saving time twice a year.

Configure Remote Access Using SSH Tunnelling - (Advanced Feature)

The S-PLAY allows the option for remote access through an SSH tunnel. This is a cost-effective method to access your device over the Internet.

Security Note – Internet Connection



- Before connecting your S-PLAY to the Internet ensure your local network firewall provides security all devices have been adequately secured.
- If ever unsure consult a qualified professional.
- Ensure you have sufficient extra bandwidth to deal with influxes of traffic caused by an internet connection.
- Ensure your SSH Tunnel is configured in such a way to ensure only trusted users can access the tunnel to remotely configure the S-PLAY.

This advanced feature requires a cloud server to be configured that will allow users to connect to it from anywhere in the world over the internet by navigating to a static URL via a browser and can be configured on the S-PLAYs Settings page.

Visit the ENTTEC Website to view the application note showing step by step configuration with an AWS Web Server.

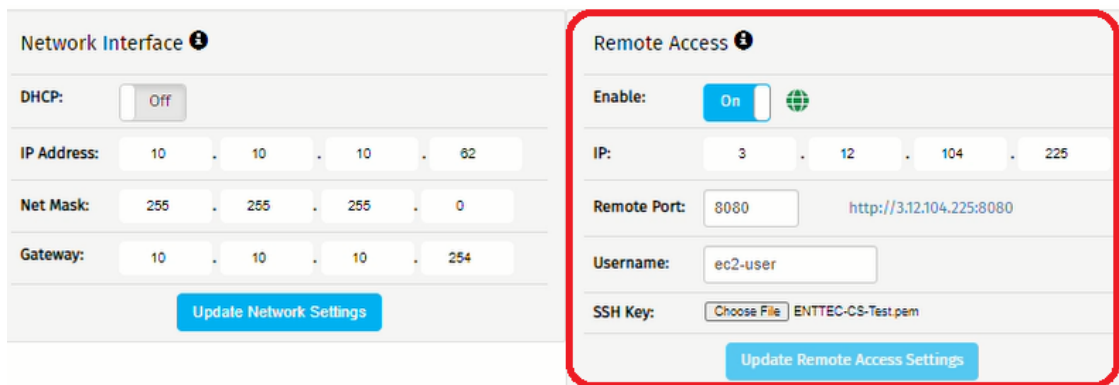
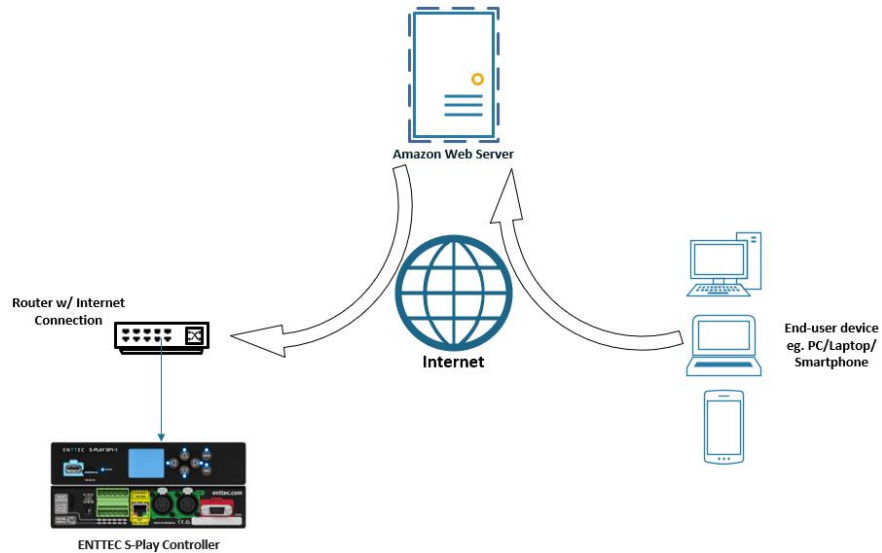

Select Storage

S-PLAY contains internal memory of 8GB+. However, if the storage is getting full, the user can switch memory to an external Class 10 SD Memory card designed for high load video recording is used. (i.e. Samsung Pro Endurance series).

S-PLAY can only operate from a single memory source so make sure to move all the files from the internal memory to the external SD card. To do so, please refer to the next section in the user manual "Export Playback Data".

When a SD card is inserted into the S-PLAY it will be wiped and re-formatted to support the Linux EXT3 file format before shows are saved onto it. Ensure all files are removed from your SD card before inserting it into the S-PLAY.

Factory Reset

A factory reset can be undertaken using either the web interface or LCD providing the user account is logged in. Performing a factory reset will result in:

- The Network settings returning to DHCP
- All cues, playlists and schedulers stored internally will be deleted
- The output universes will return to Art-Net
- Art-Net output will be set to broadcast
- sACN output will be set to multicast

Always take a backup before undertaking a factory reset.

Note: Once a factory reset has been started the process will not stop until completion.

Note: Do not remove power from the S-PLAY whilst a factory reset is in progress.



Following a successful factory reset and the S-PLAY re-booting, ENTTEC recommends removing power for 10 seconds, then re-plugging your device. Once it boots navigate to a 404 page on the device by modifying the URL to a page that doesn't exist on the S-PLAY (i.e. <http://10.0.0.100/en/404/>). This will automatically clear its web cache.

Factory Reset Via LCD

- Navigate to settings
- Locate Reset to Defaults
- Select "RESET"



Factory Reset Via Web Interface

Go to settings page, scroll down to the end of the page and click "Reset to factory Defaults".

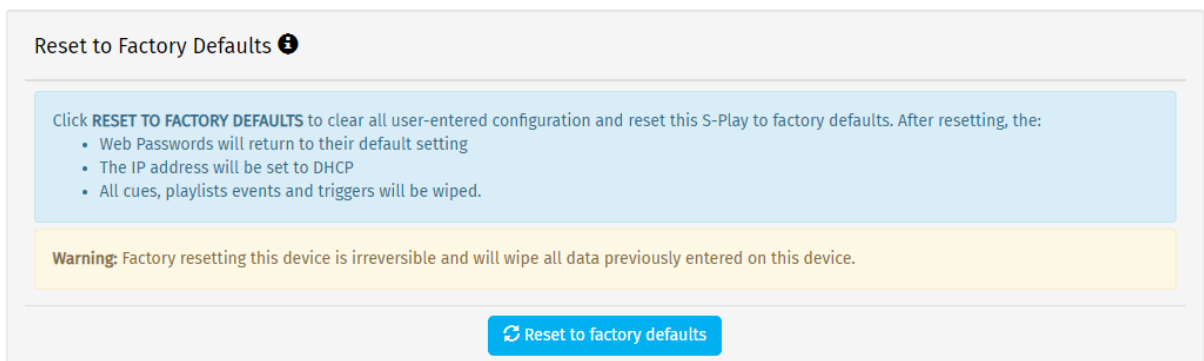

Status

The status page displays:

- Network information of the device
- Current output protocols
- System information including:
 - System status
 - Playlist activity
 - CPU status
 - Storage status
 - Device name
 - System uptime
 - Hardware ID
- Software version information
 - Firmware version

Network Information

IP Address:	10.0.0.25
Subnet Mask:	255.0.0.0
Broadcast Address:	10.255.255.255
Mac Address:	00:50:C2:08:1A:36
Serial No.:	0050c2081A36

Output Information

	Universe 1	Universe 2	Universe 3	Universe 4	Universe 5	Universe 6	Universe 7	Universe 8	Universe 9	Universe 10	Unive
Protocol	ArtNet	ArtNet	ArtNet	ArtNet	ArtNet	ArtNet	ArtNet	ArtNet	ArtNet	ArtNet	ArtNe
Universe	0	1	2	3	4	5	6	7	8	9	10
IP Address	Broadcast	Broadcast	Broadcast	Broadcast	Broadcast	Broadcast	Broadcast	Broadcast	Broadcast	Broadcast	Broac

System Information

System Status:	✔ STARTED	STOP ENGINE REBOOT
Activity:	No Playlist is Playing	
CPU Status:	Load: 1.3 % Temp: 38.9 °C	
Disk Space:	<div style="border: 1px solid #ccc; padding: 2px;"> 5.82 % used </div> SD (Internal) 8.0 GB free out of 8.5 GB	
System Name:	S-PLAY	
System Uptime:	2 hours, 15, minutes	
Hardware ID:	1651660c04424264	

Software Information

Software Version:	1.3.0
OS Build date:	Fri 08 May 2020 09:35:05 AM UTC
Web Version:	20201218.5
Engine Version:	20201218.2
DMX Driver Version:	1.5

The Status page displays the following information:

Network Information

- IP Address
- Subnet Mask
- Broadcast Address
- MAC Address
- Engine Address

Output Information

- Protocol
- Universe
- Output IP Address, (if applicable)

System Information

- Status
- Activity
- CPU Status
- Disk Space (internal and external)
- System Uptime
- Hardware ID

Software Information

- Software Information
- DMX Driver Version

Backup

The backup page allows the user to achieve the following:

- Settings backup
- Restore

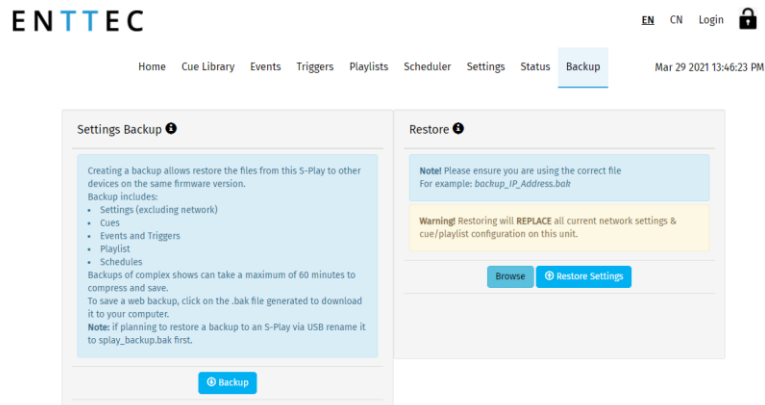

Backup

S-PLAY produces a package that includes:

- Cues
- Playlist
- Schedules
- Settings

The backup can be done via LCD and web interface.

Go to Backup page, click “Backup”. The process produces a .bak package that can be downloaded and saved to any location in your computer.

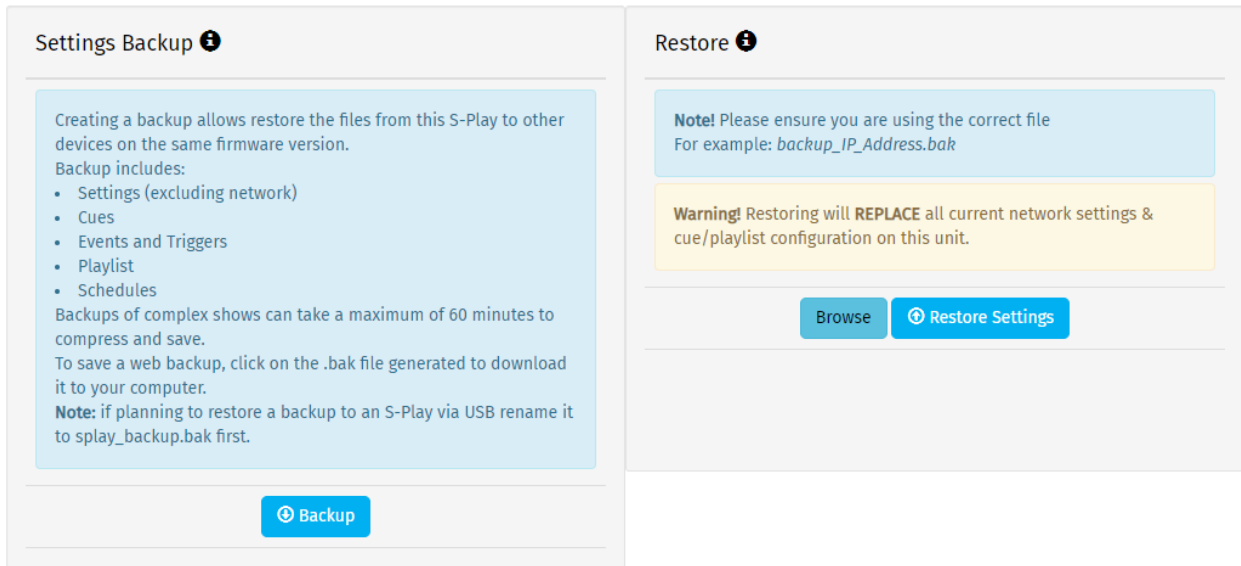

Restore

Use the created .bak file to restore cues, playlists, schedules and output settings.

Go to the Backup menu in the web interface

- Select the desired memory location (internal or external)
- Click browse and look for the .bak file
- Insert and click on restore

Once the restore is complete, a confirmation message will appear on the top of the page.

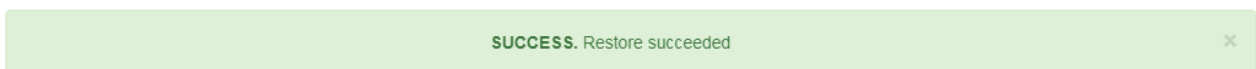
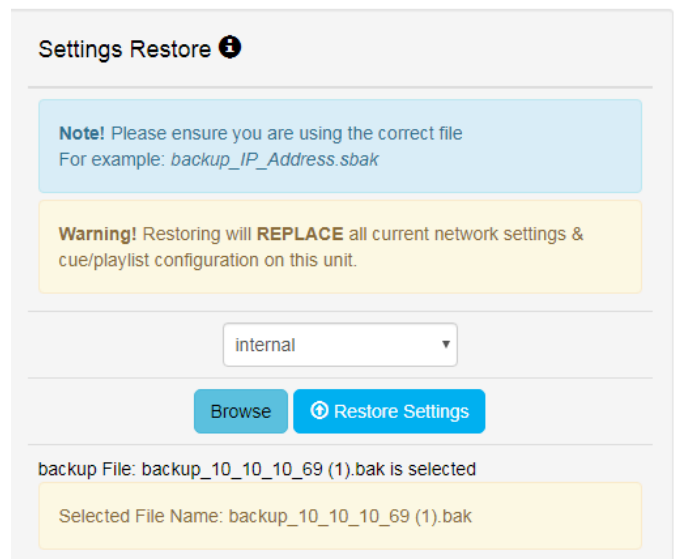

Export Playback Data

The Export Playback Data function moves:

- Cues
- Playlists
- Schedules

from the internal memory to an external SD card inserted in the front slot of the unit or vice versa.

When moving files across make sure the desired storage is selected in “Select Storage” section on the web interface.

The files are copied from one location to another. Which means that they are not deleted from the original location.

The status of both memory devices can be tracked down in the “Status” page.

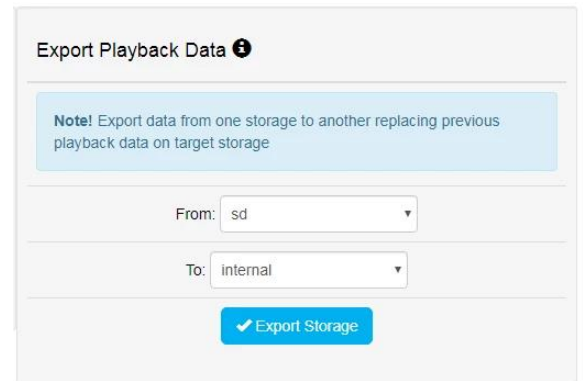

Storage

Show Storage

Static Cue

Snapshots are comprised of a single DMX frame. The maximum file size of a frame of one universe with associated metadata is 518 bytes. To calculate the file size of a Static Cue.

To calculate the theoretical file size of a static cue, multiply 518bytes by the quantity of universes you intend to capture as part of the static cue. This calculation will give a file size in bytes.

$$((518 \text{ bytes}) * (\text{Quantity of Universes to be captured})) = \text{Static Cue Size (bytes)}$$

Dynamic Cue

A dynamic cue can be thought of as a stream of Static Cues. To calculate the theoretical file size of a Dynamic Cue the size of a single 1 universe DMX frame (518 bytes) should be multiplied by the quantity of universes being captured, the quantity of frames being recorded per second and duration of recording (in seconds).

$$((518 \text{ bytes}) * (\text{Quantity of Universes}) * (\text{Frames per Second [produced by the DMX source]}) * (\text{Intended Recording Length [seconds]})) = \text{Dynamic Cue Size (bytes)}$$

Triggers & Events

Triggers and Events each have a maximum file size of 1Kb (1000bytes). To calculate the theoretical storage size all Triggers and Events your configuration will occupy, multiply the total quantity of Triggers and Events you will use by 1Kb.

$$((1000 \text{ bytes}) * (\text{Quantity of Triggers and Events})) = \text{Total Trigger and Event Size (bytes)}$$

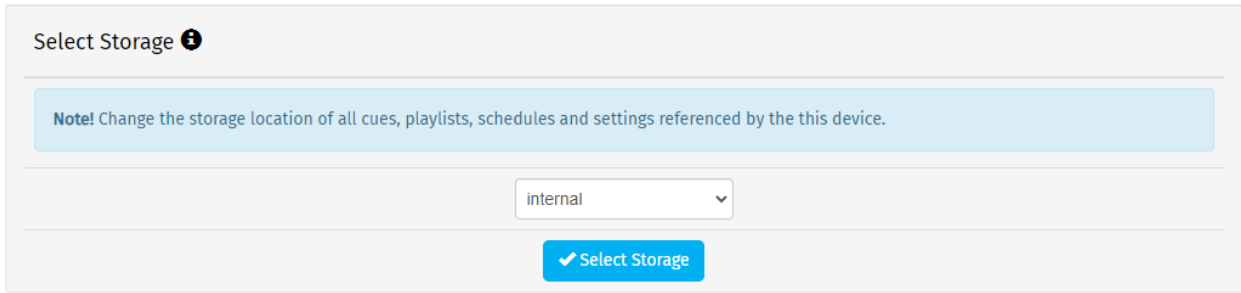

Locking the S-PLAY and User Management

S-PLAY includes a locking system to prevent settings, playlists, cues and schedulers from being modified.

Lock Feature

Out of the box, S-PLAY is unlocked which means when connected to a network any computer within the network can change settings, create cues, create playlists, trigger playlists, etc.

If the lock on the top right corner of the screen is open, as shown below, the unit is unlocked and accessible within the network.

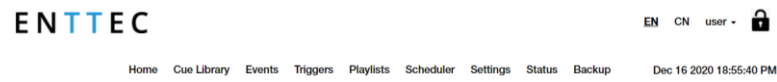

To lock the unit, simply click on the padlock in the top right-hand corner of the user interface and the unit will automatically disable all the tabs but home.

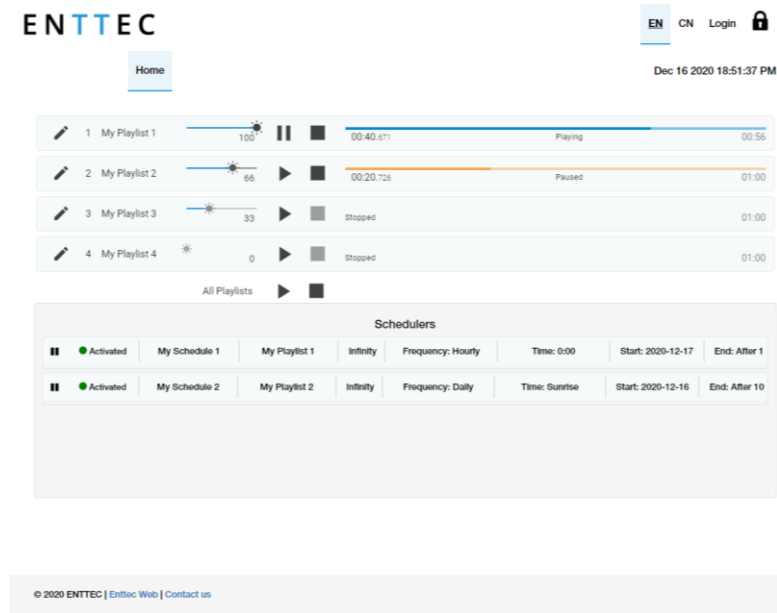

When the S-PLAY is locked, users can:

- Play and Stop any playlist.
- Play and Stop all playlists.
- Pause and Resume Schedules
- Navigate the LCD to preview cues, activate playlists and display settings.

To enable full functionality the user account must be logged in.

When a user is logged in, the unit can remain locked for the rest of the users accessing from other

locations/browsers. Within the network. However, the unit will ensure that only one browser is open at the same time when accessing "Home", "Cue Library" and/or "Playlist Page". This is to avoid having conflicting commands that can jeopardize any part of the recording process.

To unlock the S-PLAY, simply click on the padlock icon on the top right corner of the web interface.

Default Login and Passwords

User	Default Password
User	123456



Before setting a password take a full backup of your show data and settings. If the password is forgotten or lost, contact the ENTTEC support team for assistance to use the Admin log-in functionality. A full factory reset of the device is the only method to return the password to default.

Ports

XLR5 Female (DMX-512)

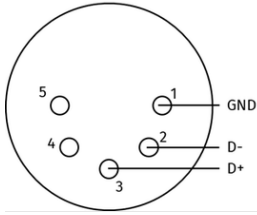

PIN	CONNECTION
1	GND
2	DATA -
3	DATA +
4	NC
5	NC

DB9 Male (RS232)

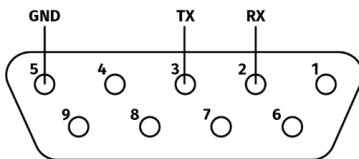

PIN	CONNECTION
1	NC
2	RX
3	TX
4	NC
5	GND
6	NC
7	NC
8	NC
9	NC

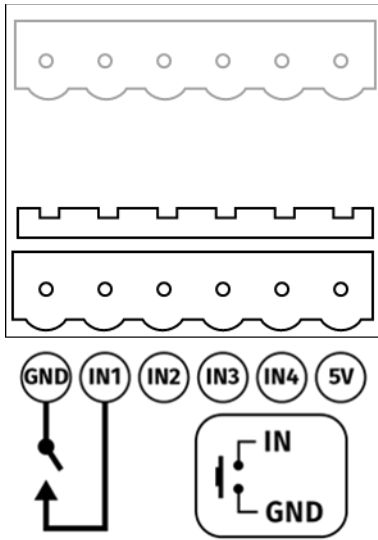

GPIO

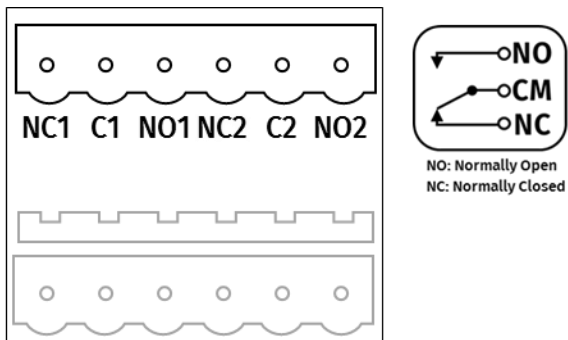

Relay



Servicing, Inspection & Maintenance

-  ■ **The device has no user serviceable parts. If your installation has become damaged, parts should be replaced.**
-  ■ **Power down the device and ensure a method is in place to stop the system from becoming energized during servicing, inspection & maintenance.**

Key areas to examine during inspection:

- Ensure all connectors are mated securely and show no sign of damage or corrosion.
- Ensure all cabling has not obtained physical damage or been crushed.
- Check for dust or dirt build up on the device and schedule cleaning if necessary.
- Dirt or dust buildup can limit the ability for a device to dissipate heat and can lead to damage.



The replacement device should be installed in accordance with all steps within the installation guide.

To order replacement devices or accessories contact your reseller or message ENTTEC directly.

Cleaning

Dust and dirt build up can limit the ability for the device to dissipate heat resulting in damage. It's important that the device is cleaned in a schedule fit for the environment it is installed within to ensure maximum product longevity.

Cleaning schedules will vary greatly depending on the operating environment. Generally, the more extreme the environment, the shorter the interval between cleaning.

-  ■ **Before cleaning, power down your system and ensure a method is in place to stop the system from becoming energized until cleaning is complete.**
-  ■ **Do not use abrasive, corrosive, or solvent-based cleaning products on an device.**
-  ■ **Do not spray device or accessories. The device is an IP20 product.**

To clean an ENTTEC device, use low-pressure compressed air to remove dust, dirt and loose particles. If deemed necessary, wipe the device with a damp microfiber cloth.

A selection of environmental factors that may increase the need for frequent cleaning include:

- Use of stage fog, smoke or atmospheric devices.
- High airflow rates (i.e., in close proximity to air conditioning vents).
- High pollution levels or cigarette smoke.
- Airborne dust (from building work, the natural environment or pyrotechnic effects).

If any of these factors are present, inspect all elements of the system soon after installation to see whether cleaning is necessary, then check again at frequent intervals. This procedure will allow you to determine a reliable cleaning schedule for your installation.

Package Contents

- S-PLAY (70092)
- 2m cat5 cable (79102)
- 1RU mount kit (79105)
- 1 X 12V PSU adaptor with international plugs
- ReadMe Card

Ordering Information

For further support and to browse ENTTEC's range of products visit the [ENTTEC website](#).

Item	Part No.
S-PLAY	70092

enttec.com

MELBOURNE AUS / LONDON UK / RALEIGH-DURHAM USA

Due to constant innovation, information within this document is subject to change.